



Smart Current Transformer

Featuring LoRaWAN®

CT3xx

User Guide



Safety Precautions

Milesight will not shoulder responsibility for any losses or damages resulting from not following the instructions of this operating guide.

- ❖ The device must not be modified in any way.
- ❖ The installation and maintenance must be conducted by a qualified service person and should strictly comply with the electrical safety regulations of the local region.
- ❖ Do not overload the maximum capacity to avoid damage to the device.
- ❖ The device is intended only for indoor use. Do not place the device where the temperature is below/above the operating range.
- ❖ Do not place the device close to objects with naked flames, heat source (oven or sunlight), cold source, liquid and extreme temperature changes.
- ❖ Keep the device away from water to prevent electric shock.
- ❖ Use the device opening clean and free of dust before installation. Dusty or dirty environments may prevent the proper operation of this device.
- ❖ Do not drop the device or subject it to physical shocks and strong vibration.

Declaration of Conformity

CT3xx is in conformity with the essential requirements and other relevant provisions of the CE, FCC, and RoHS.

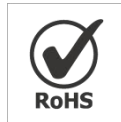

Copyright © 2011-2024 Milesight. All rights reserved.

All information in this guide is protected by copyright law. Whereby, no organization or individual shall copy or reproduce the whole or part of this user guide by any means without written authorization from Xiamen Milesight IoT Co., Ltd.

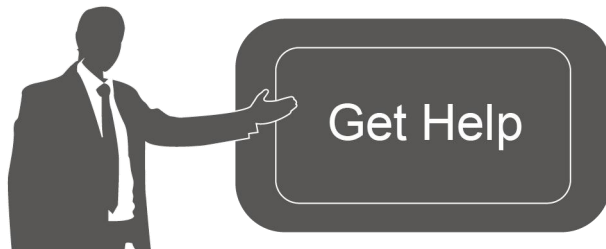

For assistance, please contact

Milesight technical support:

Email: iot.support@milesight.com

Tel: 86-592-5085280

Fax: 86-592-5023065

Address: Building C09, Software Park III,
Xiamen 361024, China

Revision History

Date	Doc Version	Description
Jun 6, 2024	V1.0	Initial version

Contents

1. Product Introduction	5
1.1 Overview	5
1.2 Features	5
2. Hardware Introduction	5
2.1 Packing List	5
2.2 Hardware Overview	6
2.3 Button and LED Indicator	6
2.4 Dimensions (mm)	6
3. Operation Guide	7
3.1 USB Configuration	7
3.2 LoRaWAN Settings	8
3.3 General & Alarm Settings	11
3.4 Maintenance	12
3.4.1 Upgrade	12
3.4.2 Backup	13
3.4.3 Reset and Reboot	13
4. Installation	14
4.1 Device Assembly	14
4.2 Antenna Installation	14
4.3 Transformer Installation	15
4.4 Transceiver Installation	16
4.5 Cable Temperature Sensor Installation (Alternative)	16
5. Communication Protocol	17
5.1 Basic Information	17
5.2 Sensor Data	18
5.3 Downlink Commands	19

1. Product Introduction

1.1 Overview

CT3xx is a LoRaWAN® Smart Current Transformer for monitoring energy consumption and analyzing usage remotely. CT3xx provides multiple current options to suit energy monitoring and supports sending threshold alarms. Its compact size enables quick and safe installation in any indoor space without de-energizing facilities, thereby simplifying the installation and saving costs. Compliant with Milesight LoRaWAN® gateway and Milesight Development Platform solution, CT3xx can be conveniently monitored via webpage remotely.

CT3xx is widely used for energy motoring of smart buildings, machine failure detection and prevention, etc.

1.2 Features

- Report the RMS current and accumulated current data by minutes
- High measuring accuracy with a sampling frequency of up to 3.3 kHz
- Self-powered, free from batteries or external wires
- Utilize a sampling rate of up to 1s for real-time monitoring and quick alarm response
- Non-invasive clamp design ensures easy and safe installation without the need for power de-energizing
- Equipped with LED indicator to indicate working status and alarms
- Support external wire temperature sensor for cable temperature measurement
- Enable simultaneous detection of three phases with a significantly wide optional detection range of either 500A or 1000A
- Compliant with standard LoRaWAN® gateways and network servers
- Compliant with Milesight Development Platform

2. Hardware Introduction

2.1 Packing List

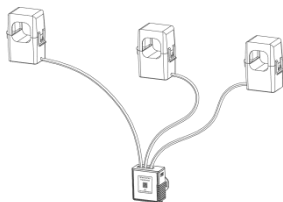

1 × CT3xx Current
Transformer

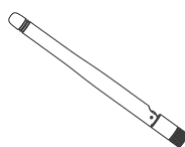

1 × LoRaWAN® Stubby
Antenna

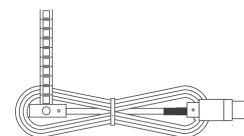

1 x Cable Temperature
Sensor (1m)



1 × LoRaWAN[®] Magnetic Antenna (Optional)

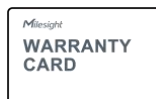

1 × Warranty Card



1 × Quick Guide

! If any of the above items is missing or damaged, please contact your sales representative.

2.2 Hardware Overview

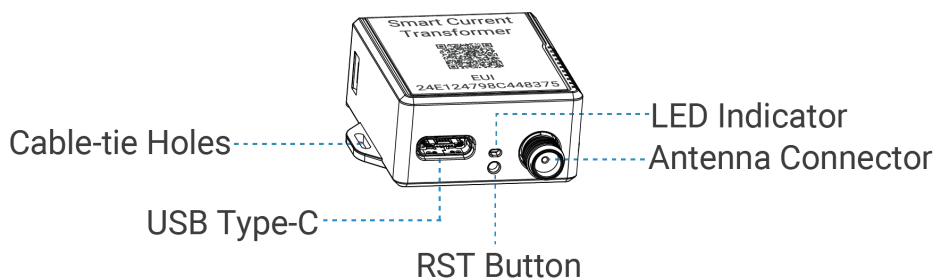

2.3 Button and LED Indicator

Function	Action	LED Indicator
Normal Work	The device is functioning properly.	Blinking every 2s
Low Power Mode	The device measures and reports at reduced rate.	Blinking every 5s
Low Voltage Mode	The device only measures at reduced rate.	Blinking every 10s
Alarm	The current is over the threshold or measuring range, or the temperature is over the threshold.	Fast Blinking
Reboot	Quick press the RST button once.	Blinking Once

2.4 Dimensions (mm)

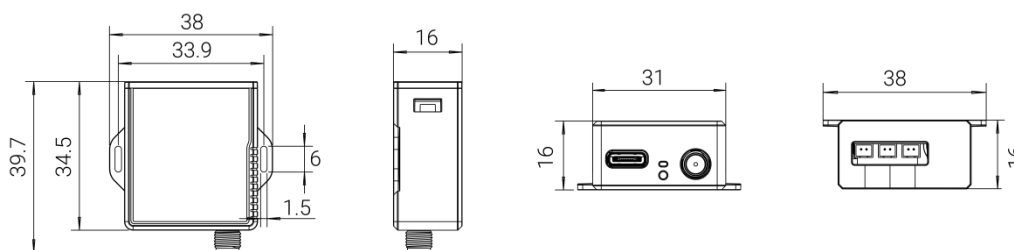

CT305

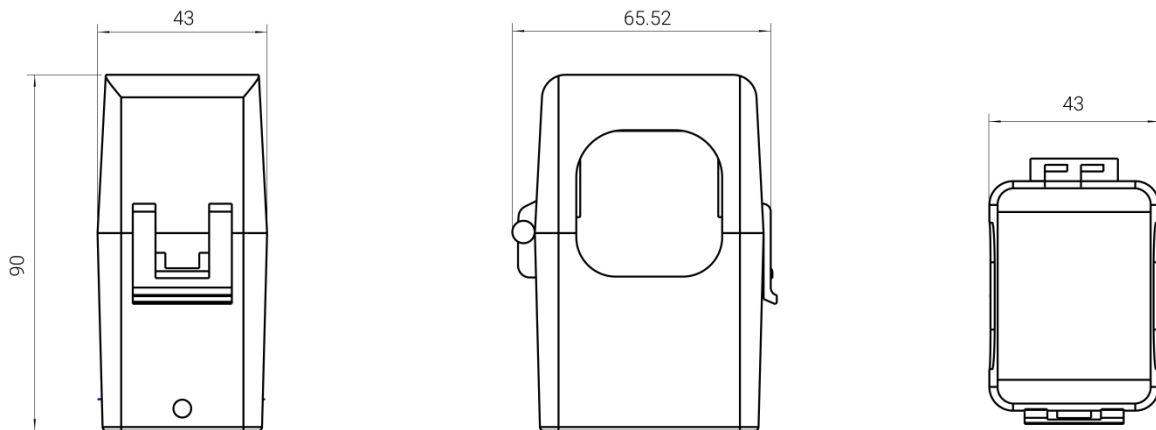

CT310

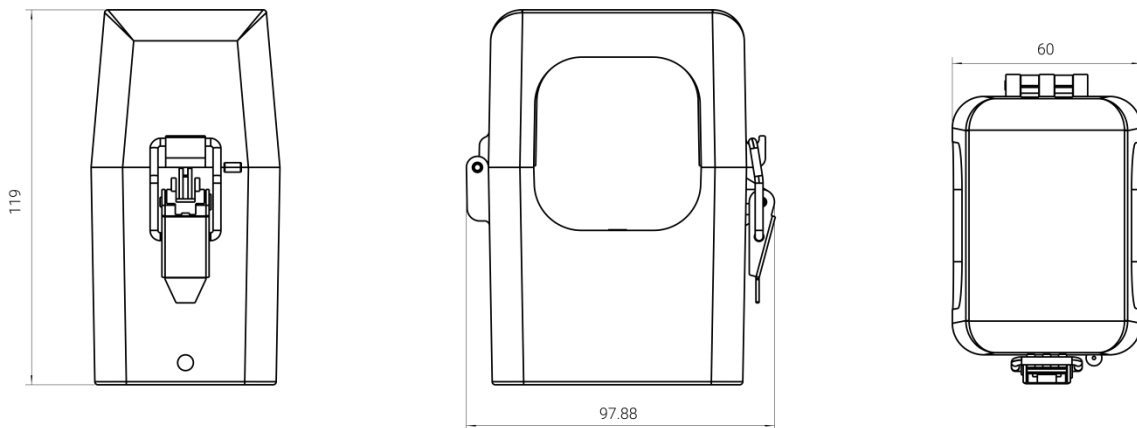

3. Operation Guide

3.1 USB Configuration

CT3xx can be powered and configured via a Type-C port for configuration and debug.

1. Download ToolBox software from Milesight website.
2. Connect the device to a computer via the Type-C port.

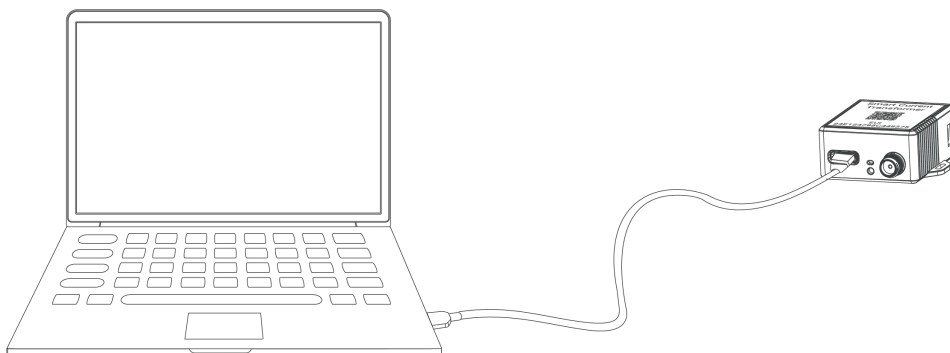

- Open the ToolBox and select type as **General**, then click password to log into the ToolBox. (Default password: **123456**)

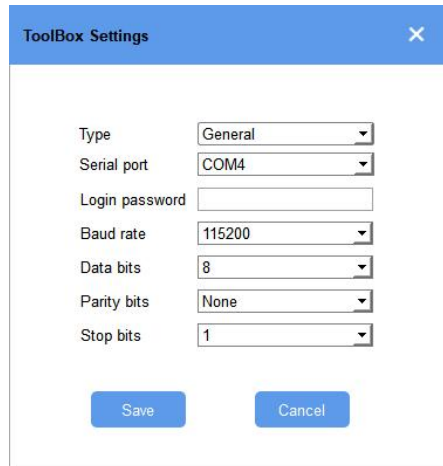

Type	General
Serial port	COM4
Login password	
Baud rate	115200
Data bits	8
Parity bits	None
Stop bits	1

Save Cancel

- After logging into the ToolBox, you can check device status and change device settings.

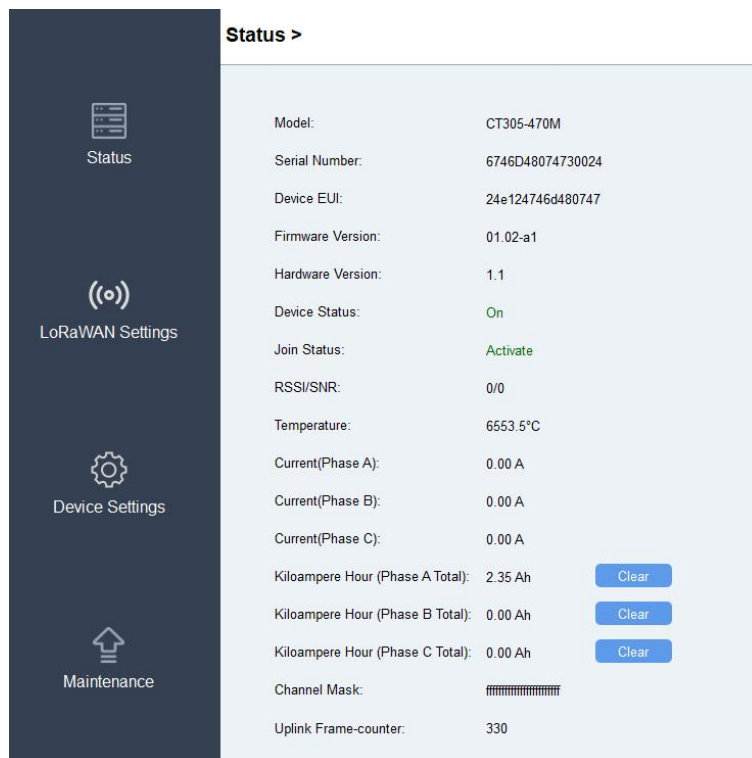

Model:	CT305-470M	
Serial Number:	6746D48074730024	
Device EUI:	24e124746d480747	
Firmware Version:	01.02-a1	
Hardware Version:	1.1	
Device Status:	On	
Join Status:	Activate	
RSSI/SNR:	0/0	
Temperature:	6553.5°C	
Current(Phase A):	0.00 A	
Current(Phase B):	0.00 A	
Current(Phase C):	0.00 A	
Kiloampere Hour (Phase A Total):	2.35 Ah	Clear
Kiloampere Hour (Phase B Total):	0.00 Ah	Clear
Kiloampere Hour (Phase C Total):	0.00 Ah	Clear
Channel Mask:		
Uplink Frame-counter:	330	

3.2 LoRaWAN Settings

LoRaWAN settings are used to configure the data transmission parameters in the LoRaWAN® network.

Basic LoRaWAN Settings:

CT3xx supports basic configurations like join type, App EUI, App Key, and other information. You can also keep all settings by default.

Device EUI	<input type="text" value="24E124756C221863"/>
App EUI	<input type="text" value="24E124C0002A0001"/>
Application Port	<input type="text" value="85"/>
Join Type	<input type="text" value="OTAA"/>
Application Key	<input type="text" value="*****"/>
RX2 Data Rate	<input type="text" value="DR8 (SF12, 500k)"/>
RX2 Frequency	<input type="text" value="923300000"/>
Spread Factor	<input type="text" value="SF8-DR2"/>
Confirmed Mode	<input type="checkbox"/>
Rejoin Mode	<input checked="" type="checkbox"/>
Set the number of packets sent	<input type="text" value="32"/> packets
ADR Mode	<input checked="" type="checkbox"/>
TXPower	<input type="text" value="TXPower0-22 dBm"/>

Parameters	Description
Device EUI	Unique ID of the device which can also be found on the label.
App EUI	Default App EUI is 24E124C0002A0001.
Application Port	The port used for sending and receiving data, default port is 85.
Join Type	OTAA and ABP modes are available.
Application Key	Appkey for OTAA mode, default is 5572404C696E6B4C6F52613230313823.
Device Address	DevAddr for ABP mode, default is the 5 th to 12 th digits of SN.
Network Session Key	Nwkskey for ABP mode, default is 5572404C696E6B4C6F52613230313823.
Application Session Key	Appskey for ABP mode, default is 5572404C696E6B4C6F52613230313823.
RX2 Data Rate	RX2 data rate to receive downlinks.
RX2 Frequency/MHz	RX2 frequency to receive downlinks.
Spread Factor	If ADR is disabled, the device will send data via this spread factor.
Confirmed Mode	If the device does not receive the ACK packet from network server, it will resend data once.

Rejoin Mode	<p>Reporting interval \leq 35 mins: the device will send a specific number of LinkCheckReq MAC packets to the network server every reporting interval or every double reporting interval to validate connectivity; If there is no response, the device will re-join the network.</p> <p>Reporting interval $>$ 35 mins: the device will send a specific number of LinkCheckReq MAC packets to the network server every reporting interval to validate connectivity; If there is no response, the device will re-join the network.</p> <p>Note: Only OTAA mode supports rejoin mode.</p>
Set the number of packets sent	<p>When rejoin mode is enabled, set the number of LinkCheckReq packets sent.</p> <p>Note: the actual sending number is Set the number of packets sent + 1.</p>
ADR Mode	Allow the network server to adjust the data rate of the device.
Tx Power	Transmit power of the device.

Note:

- 1) Please contact your sales representative for the device EUI list if there are many units.
- 2) Please contact your sales representative if you need random App keys before purchase.
- 3) Select OTAA mode if you use Milesight Development Platform to manage devices.

LoRaWAN Frequency Settings:

Select supported frequency and channels to send uplinks. Make sure the channels match the LoRaWAN® gateway.

Supported Frequency : EU868

<input type="checkbox"/>	Index	Frequency/MHz	Min Datarate	Max Datarate
<input checked="" type="checkbox"/>	0	868.1	5-SF7BW125	0-SF12BW125
<input checked="" type="checkbox"/>	1	868.3	5-SF7BW125	0-SF12BW125
<input checked="" type="checkbox"/>	2	868.5	5-SF7BW125	0-SF12BW125
<input type="checkbox"/>	3	0	5-SF7BW125	0-SF12BW125
<input type="checkbox"/>	4	0	5-SF7BW125	0-SF12BW125
<input type="checkbox"/>	5	0	5-SF7BW125	0-SF12BW125
<input type="checkbox"/>	6	0	0-SF12BW125	5-SF7BW125
<input type="checkbox"/>	7	0	0-SF12BW125	5-SF7BW125

If the device frequency is one of CN470/AU915/US915, you can enter the index of the channel that you want to enable in the input box, making them separated by commas.

Examples:

1, 40: Enabling Channel 1 and Channel 40

1-40: Enabling Channel 1 to Channel 40

1-40, 60: Enabling Channel 1 to Channel 40 and Channel 60

All: Enabling all channels

Null: Indicates that all channels are disabled

Supported Frequency : US915

Enabled Channel Index:

Channel Index	Frequency/MHz	Channel Spacing/MHz	BW/kHz
0 - 15	902.3 - 905.3	0.2	125
16 - 31	905.5 - 908.5	0.2	125
32 - 47	908.7 - 911.7	0.2	125
48 - 63	911.9 - 914.9	0.2	125
64 - 71	903.0 - 914.2	1.6	500

Note:
64 channels numbered 0 to 63 utilizing LoRa 125 kHz BW starting at 902.3 MHz and incrementing linearly by 0.2 MHz to 914.9
8 channels numbered 64 to 71 utilizing LoRa 500 kHz BW starting at 903.0 MHz and incrementing linearly by 1.6 MHz to 914.2

3.3 General & Alarm Settings

Basic Settings

Device Type

Reporting Interval (min)

Change Password

Parameters	Description
Reporting Interval	<p>The interval of reporting current data.</p> <p>Default: 10 mins, Range: 1 - 1440 mins</p> <p>Note: when the device is under low power mode, the interval is fixed as 30 minutes; when the device is under low voltage mode, the device will stop reporting. The working mode can be judged by LED indicator.</p>
Change Password	Change the password of the device for ToolBox configuration.

Alarm Settings

Current Threshold(Phase A)

Excessive Current Threshold

Insufficient Current Threshold

Current Threshold(Phase B)

Current Threshold(Phase C)

Temperature

Over °C

Below °C

Alarm Reporting Interval(min)

Alarm Reporting Times

Parameters	Description
Alarm Reporting Interval (min)	The interval to report alarm packet after alarm triggers. This interval should be less than reporting interval.
Alarm Reporting Times	Alarm packet report times after alarm triggers.
Current Threshold (Phase x)	
Excessive Current Threshold	The maximum current threshold value.
Insufficient Current Threshold	The minimum current threshold value.
Temperature	
Over	The maximum temperature threshold value.
Below	The maximum temperature threshold value.

Note: Current overrange alarm is fixed as enabled, the alarm reporting interval is fixed as 5 minutes and the alarm reporting time is fixed as 3.

3.4 Maintenance

3.4.1 Upgrade

1. Download firmware from Milesight website to your PC.
2. Go to **Maintenance > Upgrade**, click **Browse** to import firmware and click **Upgrade** to upgrade the device.

Maintenance >

Upgrade Backup and Reset

Model: CT305-915M

Firmware Version: 01.02-a1

Hardware Version: 1.1

Domain: Beijing Server

FOTA: Up to date

Local Upgrade Browse Upgrade

3.4.2 Backup

CT3xx supports configuration backup for easy and quick device configuration in bulk. Backup is allowed only for devices with the same model and LoRaWAN® frequency band.

1. Go to **Maintenance > Backup and Reset**, and click **Export** to backup the device configuration.
2. Click **Browse** to import the backup file, then click **Import** to load the configuration.

Maintenance >

Upgrade Backup and Reset

Config Backup Export

Config File Browse Import

Restore Factory Defaults Reset

3.4.3 Reset and Reboot

Reset to Factory Default: Go to **Maintenance > Backup and Reset** of ToolBox, and click **Reset** to complete.

Maintenance >

Upgrade Backup and Reset

Config Backup Export

Config File Browse Import

Restore Factory Defaults Reset

Reboot: Quick press the RST button once or send downlink command to reboot.

4. Installation

4.1 Device Assembly

The CTs can be connected to the connectors of transceiver without any specific order matching requirement.

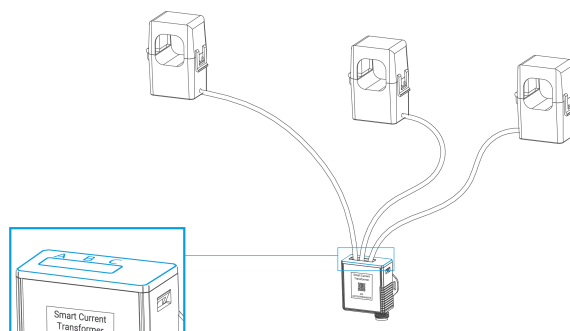

4.2 Antenna Installation

Rotate the antenna into the antenna connector. The antenna should be installed vertically and kept away from metal objects and obstacles.

Note: Keep the device away from metal objects, obstacles, or the environment surrounded by other electrical equipment that may cause interference. If necessary, please select a magnetic antenna.

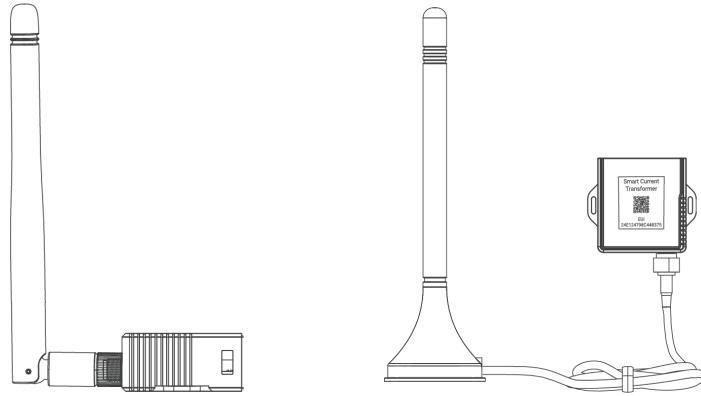

4.3 Transformer Installation

Open the current transformer to clip it around a single-phase wire. Then close the clip with a slight “click” sound to make sure the clip firmly grips the wire.

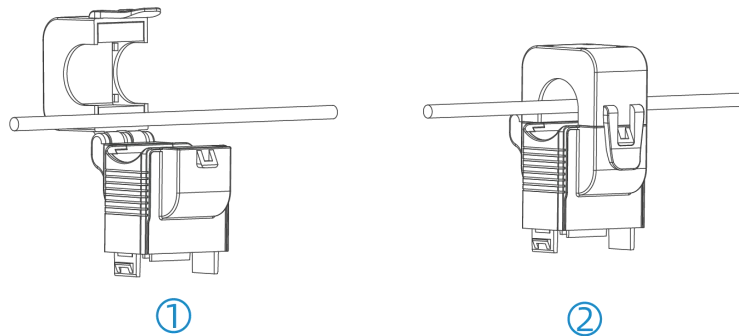

Note:

1) Do not place Phase wire and Neutral wire within a single current transformer.

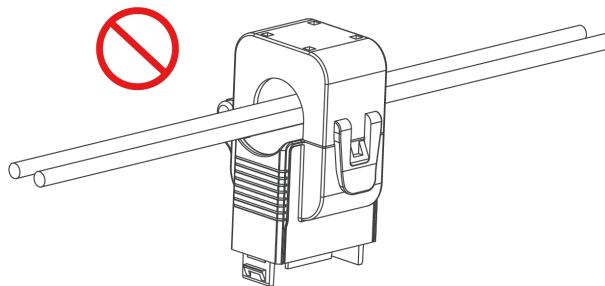

2) Please make sure at least connect a phase A CT to phase A wire, otherwise the device will be powered off.

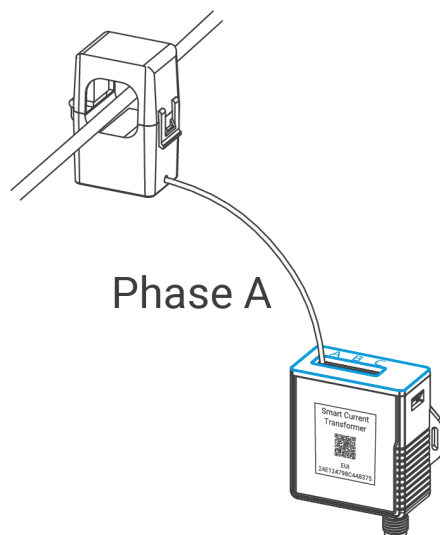

4.4 Transceiver Installation

The transceiver can be put or hang in any suitable position or to be fixed via cable-ties.

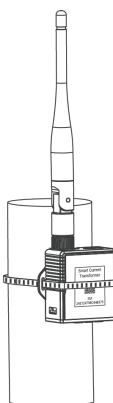

4.5 Cable Temperature Sensor Installation (Alternative)

CT3xx can monitor the temperature of one wire through the Cable Temperature Sensor, it will alarm when the temperature exceeds the threshold.

Pass the Cable Temperature Sensor around the tested wire, and then tighten the buckle. The other end is connected to the CT3xx device via the USB Type-C .

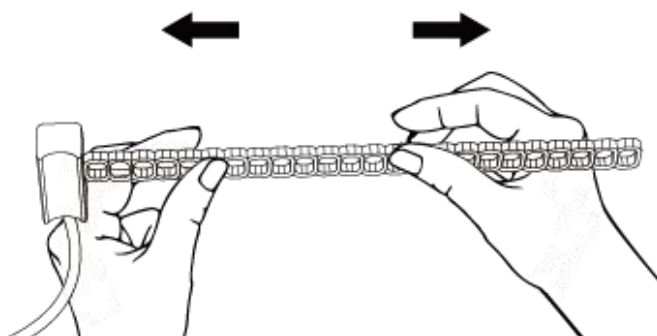

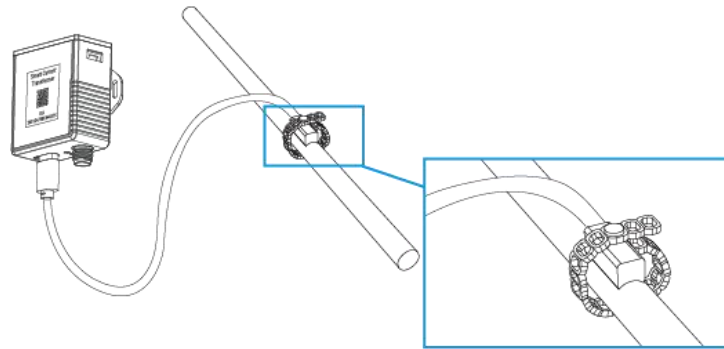

Note: Keep the Cable Temperature Sensor as close to the wire connector as possible to better detect the temperature.

5. Communication Protocol

All data are based on the following format (HEX), the Data field should follow little endian:

Channel1	Type1	Data1	Channel2	Type2	Data2	Channel 3	...
1 Byte	1 Byte	N Bytes	1 Byte	1 Byte	M Bytes	1 Byte	...

For decoder examples you can find at <https://github.com/Milesight-IoT/SensorDecoders>.

5.1 Basic Information

CT3xx reports basic information of the device whenever it joins the network.

Channel	Type	Byte	Description
ff	01(Protocol Version)	1	01=>V1
	09 (Hardware Version)	2	02 10=>V2.1
	0a(Software Version)	2	01 01=>V1.1
	ff(TSL Version)	2	01 01=>V1.1
	0b (Power On)	1	Device is on
	0f(Device Type)	1	00 = Class A, 01 = Class B, 02 = Class C
	16 (Device SN)	8	16 digits

Example:

ff0bff ff0101 ffff0101 ff166746d48016300014 ff090110 ff0a0101 ff0f00					
Channel	Type	Value	Channel	Type	Value
ff	0b (Power On)	ff (Reserved)	ff	01 (Protocol Version)	01 (V1)
Channel	Type	Value	Channel	Type	Value
ff	ff (TSL Version)	0101 (V1.1)	ff	16 (Device SN)	6746d48 0163000 14

Channel	Type	Value	Channel	Type	Value
ff	09 (Hardware Version)	0110 (V1.1)	ff	0a (Software Version)	0101 (V1.1)
Channel	Type	Value			
ff	0f (Device Type)	00 (Class A)			

5.2 Sensor Data

Item	Channel	Type	Byte	Description
Phase A Total Current	03	97	4	UINT32/100, Unit: Ah, Resolution: 0.01 Ah Note: when it reaches to max value FFFFFFFF (42949672.95), it will clear to 0 automatically.
Phase B Total Current	05			
Phase C Total Current	07			
Phase A Current	04	98	2	UINT16/100, Unit: A, Resolution: 0.01 A Note: FFFF means collection failure.
Phase B Current	06			
Phase C Current	08			
Phase A Current Alarm	84	98	7	Max. Current (2B) + Min. Current (2B) + Latest Current (2B) + Alarm Status (1B) Alarm Status: 01: Threshold alarm 02: Threshold alarm dismiss 04: Overrange alarm 08: Overrange alarm dismiss Note: Max./Min. Current means the maximum or minimum value between last report and current report.
Phase B Current Alarm	86			
Phase C Current Alarm	88			
Temperature	09	67	2	INT16/10, Unit: °C Note: FFFD means overrange temperature; FFFF means collection failure.
Temperature Alarm	89	67	3	Temperature (2B) + Alarm Status (1B) Temperature: INT16/10, Unit: °C Alarm Status: 01-Threshold alarm; 00-Threshold alarm

				dismiss
--	--	--	--	---------

Example:

1. Periodic package: report as reporting interval (10 minutes by default).

039710270000 0498b80b 059710270000 0698b80b 079710270000 0898b80b 09673401					
Channel	Type	Value	Channel	Type	Value
03	97 (Phase A Total Current)	10 27 00 00=>00 00 27 10=10000/100 =100 Ah	04	98 (Phase A Current)	b8 0b=>0b b8 =3000/100 =30A
05	97 (Phase B Total Current)	10 27 00 00=>00 00 27 10=10000/100 =100 Ah	06	98 (Phase B Current)	b8 0b=>0b b8 =3000/100 =30A
07	97 (Phase C Total Current)	10 27 00 00=>00 00 27 10=10000/100 =100 Ah	08	98 (Phase C Current)	b8 0b=>0b b8 =3000/100 =30A
09	67(Temperature)	34 01=>01 34=308/10=30.8°C			

2. Phase A current alarm or alarm dismiss packet:

8498 b80b d007 c409 01		
Channel	Type	Value
84	98(Phase A Current)	Max. Current: b8 0b=>0b b8=3000/100=30A Min. Current: d0 07=>07 d0=2000/100=20A Latest Current: c4 09=>09 c4=2500/100=25A Alarm Status: 01=> Threshold alarm

5.3 Downlink Commands

CT3xx supports downlink commands to configure the device. The application port is 85 by default.

Command	Channel	Type	Description
Reboot	ff	10	ff
Reporting Interval	ff	8e	00 + Interval Time(2B), unit: min
Threshold Alarm	ff	06	9 Bytes, CTRL (1B) + Min (2B) + Max (2B) + 00000000(4B) CTRL: ● Bit2~Bit0:

			000 - disable; 001 - below; 010 - over; 011 - within; 100 - below or over ● Bit5~Bit3: 001 - Phase A current; 010 - Phase B current; 011 - Phase C current; 100 - Temperature ● Bit7~Bit6: 00 Max./Min. Threshold unit: A or 0.1°C
Clear Accumulated Current	ff	27	01: Phase A; 02: Phase B; 03: Phase C Note: when it reaches to max value FFFFFFFF (42949672.95Ah), it will clear to 0 automatically.
Alarm Reporting Interval	ff	02	2 Bytes, unit: min, range: 1~1440
Alarm Reporting Times	ff	f2	2 Bytes, range: 1~1000

Example:

1. Set reporting interval as 20 minutes.

ff8e 00 1400		
Channel	Type	Value
ff	8e (Reporting Interval)	14 00=>00 14= 20 mins

2. Reboot the device.

ff10ff		
Channel	Type	Value
ff	10 (Reboot)	ff

3. Enable Phase A current threshold alarm and set maximum threshold as 60A.

ff 06 0a00003c00 00000000		
Channel	Type	Value
ff	06	CTRL:0a=00001010=>over Phase A current maximum threshold Min: 00 00=0 Max: 3c 00=> 00 3c=60 A

4. Set alarm reporting times as 10.

fff2 0a00		
Channel	Type	Value
ff	f2 (Alarm Reporting Times)	0a 00=>00 0a=10

-END-