



AI ToF People Counting Sensor

Featuring LoRaWAN®

VS133

User Guide



Safety Precautions

Milesight will not shoulder responsibility for any loss or damage resulting from not following the instructions of this operating guide.

- ❖ Though the device is compliant with Class 1 (IEC/EN 60825-1:2014), please **DO NOT** look at the ToF sensor too close and directly.
- ❖ The device must not be disassembled or remodeled in any way.
- ❖ To avoid risk of fire and electric shock, do keep the product away from rain and moisture before installation.
- ❖ Do not place the device where the temperature is below/above the operating range.
- ❖ **Do not touch the device directly to avoid the scalds when the device is running.**
- ❖ The device must never be subjected to shocks or impacts.
- ❖ Make sure the device is firmly fixed when installing.
- ❖ Do not expose the device to where laser beam equipment is used.
- ❖ Use a soft, dry cloth to clean the lens of the device.

Declaration of Conformity

VS133 is in conformity with the essential requirements and other relevant provisions of the CE, FCC, and RoHS.



Copyright © 2011-2023 Milesight. All rights reserved.

All information in this guide is protected by copyright law. Whereby, no organization or individual shall copy or reproduce the whole or part of this user guide by any means without written authorization from Xiamen Milesight IoT Co., Ltd.

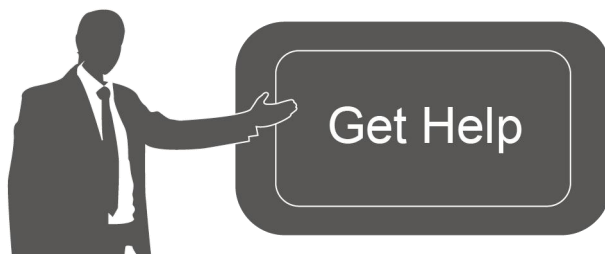

For assistance, please contact

Milesight technical support:

Email: iot.support@milesight.com

Support Portal: support.milesight-iot.com

Tel: 86-592-5085280

Fax: 86-592-5023065

Address: Building C09, Software Park
Phase III, Xiamen 361024,
China

Revision History

Date	Doc Version	Description
May 24, 2023	V 1.0	Initial version
Aug. 10, 2023	V 1.1	<ol style="list-style-type: none">1. Add staff lanyard accessory;2. Add installation height detection feature;3. Add DST time feature;4. Add ToF frequency setting.
Sep. 28, 2023	V1.2	<ol style="list-style-type: none">1. Add Region Monitoring function;2. Add Feet Tracking tracking mode of counting;3. Add preview layout edition feature;4. Add cumulative count reset schedule feature.
Nov. 30, 2023	V1.3	<ol style="list-style-type: none">1. Add Group Counting function;2. Add video validation function;3. Add other functions.

Contents

1. Product Introduction	5
1.1 Overview	5
1.2 Key Features	5
2. Hardware Introduction	5
2.1 Packing List	5
2.2 Hardware Overview	6
2.3 Button and LED Indicators	6
2.4 Dimensions (mm)	7
3. Power Supply	7
4. Access the Sensor	7
5. Operation Guide	8
5.1 Dashboard	8
5.2 Rule	9
5.3 Communication	14
5.3.1 WLAN	14
5.3.2 LoRa	15
5.4 Report	17
5.5 Validation	19
5.6 System	20
5.6.1 Device Info	20
5.6.2 User	21
5.6.3 Time Configuration	22
5.6.4 System Maintenance	23
6. Installation Instruction	24
6.1 Installation Height	24
6.2 Covered Detection Area	25
6.3 Environment Requirements	25
6.4 Installation	26
6.5 Factors Affecting Accuracy	29
7. Communication Protocol	29
7.1 Uplink Data	29
7.2 Downlink Command	30

1. Product Introduction

1.1 Overview

VS133 is a sensor that uses second-generation ToF technology to accurately count people. This technology provides more precise depth maps and longer detection distances while maintaining an excellent privacy protection rate. The advanced ToF technology combined with an AI algorithm enables the sensor to handle complex scenes and distinguish non-human objects with up to 99.8% accuracy. VS133 sensor can be used in conjunction with the Milesight LoRaWAN® gateways and the Milesight IoT Cloud. With easy installation, VS133 sensors are ideal for entrances or corridors in retail stores, malls, offices, subways, and other locations.

1.2 Key Features

- Up to 99.8% accuracy combining the 2nd generation ToF technology and AI algorithm
- Working well even in low-light or completely dark environments with great lighting adaptability
- Free from privacy concerns without image capturing
- Allow to collect people counting data by differentiating between children and adults and detecting staffs via identification features for clearer people analysis
- Smart U-turn detection to filter redundant counting of people wandering in the area
- Support queuing management via dwell time detection and regional people counting
- Support Group Counting function that based on the distance, moving direction, and speed difference to gain deeper insights into customers' behaviors
- Wider field angle to obtain longer-distance depth maps and cover a larger area
- Automatically detect the optimal installation height, facilitating fast deployment and intelligent detection
- Store a million counting data locally and securely
- Support video validation function to help customers verify statistical accuracy
- Easy configuration via Wi-Fi for web GUI configuration
- Function well with standard LoRaWAN® gateways and network servers
- Quick and easy management with Milesight IoT Cloud

2. Hardware Introduction

2.1 Packing List

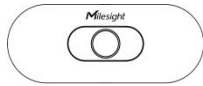

1 x VS133 Device



4 x Ceiling Mounting Kits

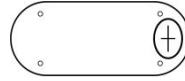

1 x Mounting Sticker



8 x Staff Tags



1 x Power Adapter

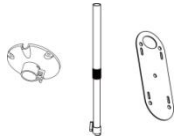

1 x VB01 Multifunctional Bracket Kit (Optional)



8 x Staff Lanyards (Optional)



1 x Quick Guide



1 x Warranty Card

! If any of the above items is missing or damaged, please contact your sales representative.

2.2 Hardware Overview

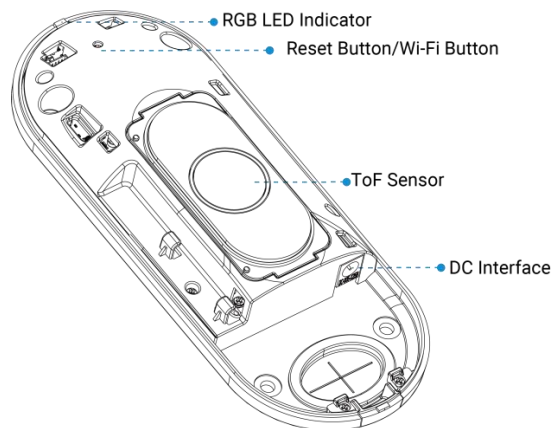

2.3 Button and LED Indicators

Function	Action	LED Indication
Turn On/Off Wi-Fi	Press and hold the button for more than 3 seconds.	Blue blinks 3s Wi-Fi on: Blue on

		Wi-Fi off: Green on
Reset to Factory Default	Press and hold the reset button for more than 10 seconds.	Green Blinks.

2.4 Dimensions (mm)

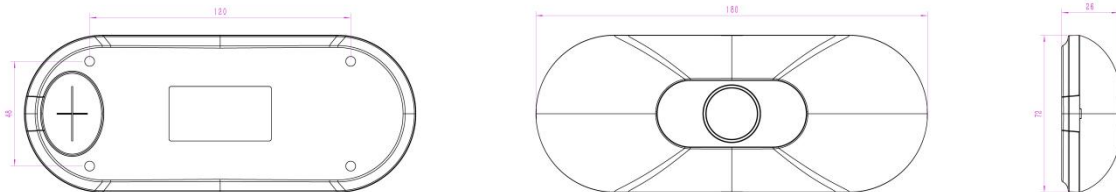

3. Power Supply

VS133 can be powered by power adapter (12VDC, 2A).

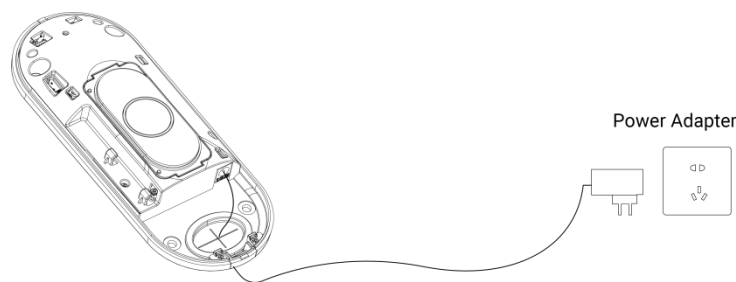

4. Access the Sensor

VS133 provides user-friendly web GUI for configuration and users can access it via Wi-Fi connection. The recommended browsers are Chrome and Microsoft Edge. The default IP of Wi-Fi is **192.168.1.1**, and default SSID is **People Counter_XXXXXX** (can be found on the label).

Step 1: Power on the device.

Step 2: Enable the Wireless Network Connection on your computer and search for corresponding access point, then connect computer to this access point.

Step 3: Open the Browser and type 192.168.1.1 to access the web GUI.

Step 4: Select the language.

Step 5: Users need to set the password and three security questions when using the sensor for the first time (three questions can be skipped by refreshing webpage). After configuration, log in with username (admin) and custom password.

Note:

- 1) Password must be 8 to 16 characters long, which contains at least two kinds or more in combination with numbers, lowercase letters, uppercase letters and special characters .
- 2) You can click the "forgot password" in login page to reset the password by answering three

security questions when you forget the password if you set the security questions in advance.

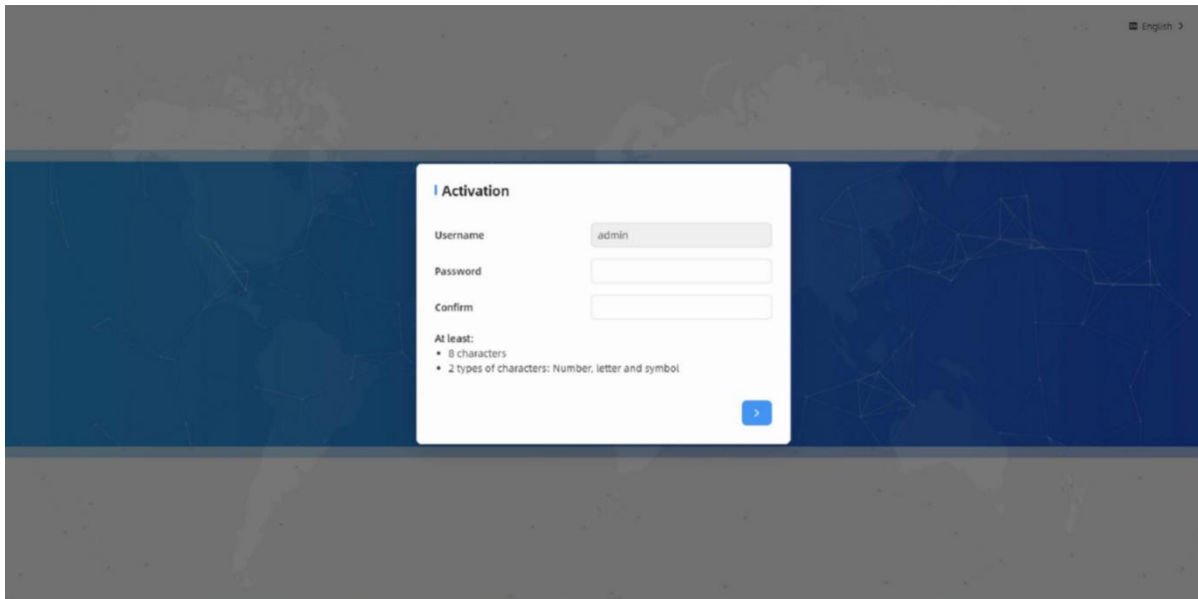

The screenshot shows a web interface with a dark blue background and a white modal window titled "Activation". The modal contains the following fields and text:

- Username:** A text input field containing the value "admin".
- Password:** A text input field.
- Confirm:** A text input field.
- At least:**
 - 8 characters
 - 2 types of characters: Number, letter and symbol
- A blue button with a right-pointing arrow at the bottom right.

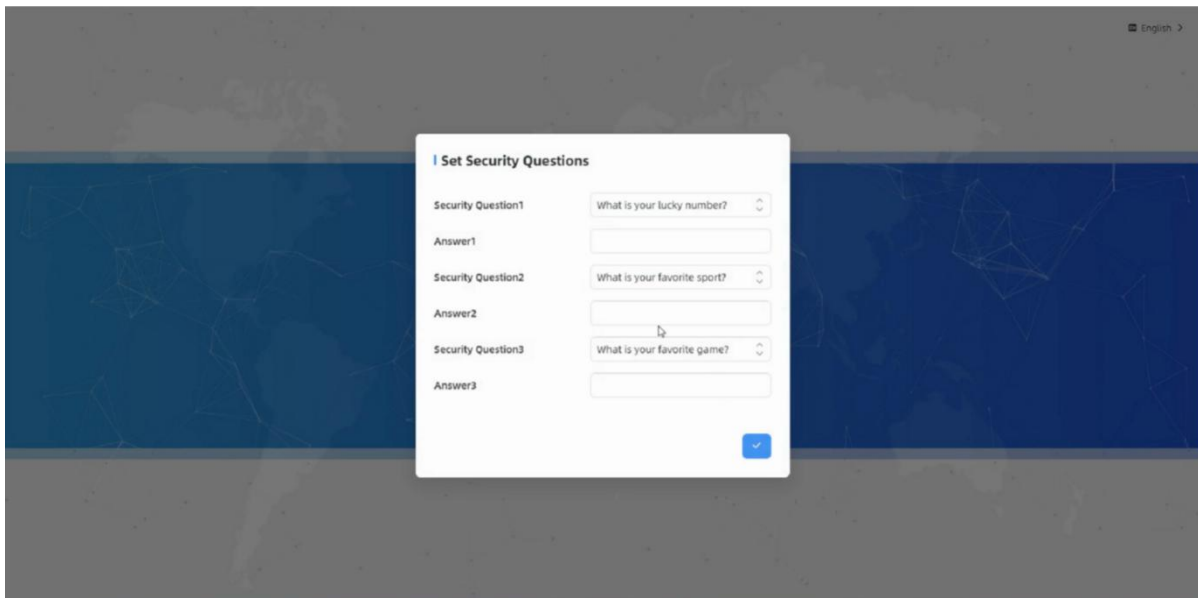

The screenshot shows a web interface with a dark blue background and a white modal window titled "Set Security Questions". The modal contains the following fields and text:

- Security Question1:** A dropdown menu with the selected option "What is your lucky number?".
- Answer1:** A text input field.
- Security Question2:** A dropdown menu with the selected option "What is your favorite sport?".
- Answer2:** A text input field.
- Security Question3:** A dropdown menu with the selected option "What is your favorite game?".
- Answer3:** A text input field.
- A blue button with a checkmark at the bottom right.

5. Operation Guide

5.1 Dashboard

After logging on to the device web GUI successfully, user is allowed to view live video as follows.

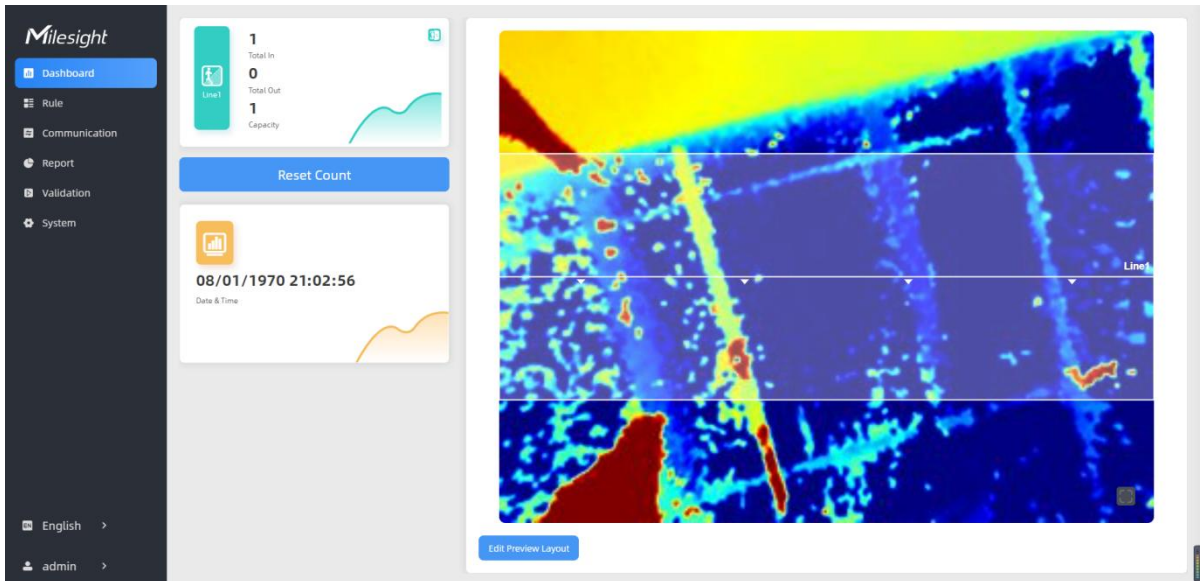

Parameters	Description
	<p>Hide Capacity: Hide the total count data capacity; Staff Excluded: Exclude staff data from statistical data; Children Excluded: Exclude children data from statistical data.</p>
Reset Count	Clear all accumulated entrance and exit people counting values.
Edit Preview Layout	<p>Click to edit the preview layout.</p> <p>Step 1: Select video stream preview, static image preview or no image preview as needed.</p> <p>Step 2: Click to show tracking lines, detection lines, U-turn areas and detection regions as needed.</p> <div data-bbox="411 1220 989 1624" style="border: 1px solid #ccc; padding: 10px;"> <p>Edit Preview Layout</p> <p>Scene Preview: Video Stream Static Images No Image</p> <p>Show Tracking Lines: <input checked="" type="checkbox"/></p> <p>Show Detection Lines: <input checked="" type="checkbox"/></p> <p>Show U-turn Areas: <input checked="" type="checkbox"/></p> <p>Show Detection Regions: <input checked="" type="checkbox"/></p> <p style="text-align: right;">✕ ✓</p> </div>

5.2 Rule

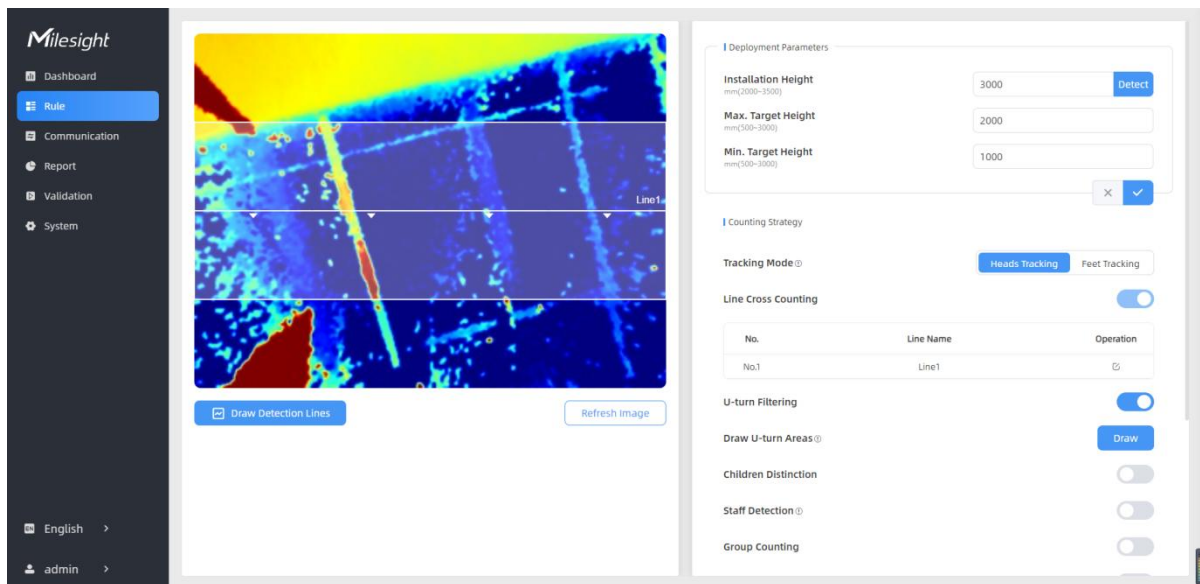

Draw Detection Lines

Users can draw detection lines to record the people count values which indicate the number of people enter or exit.

Step 1: Click **Draw Detection Lines**.

Step 2: Left-click to start drawing and drag the mouse to draw a line, left-click again to continue drawing a different direction edge and right-click the mouse to complete the drawing. The line can be dragged to adjust the location and length. One device supports at most 4 broken lines with maximum 4 segments each.

Step 3: If users need to delete the line, click **Draw Detection Lines** and select the line which need to be deleted, then click **Clear This Line** or click **Clear All**.

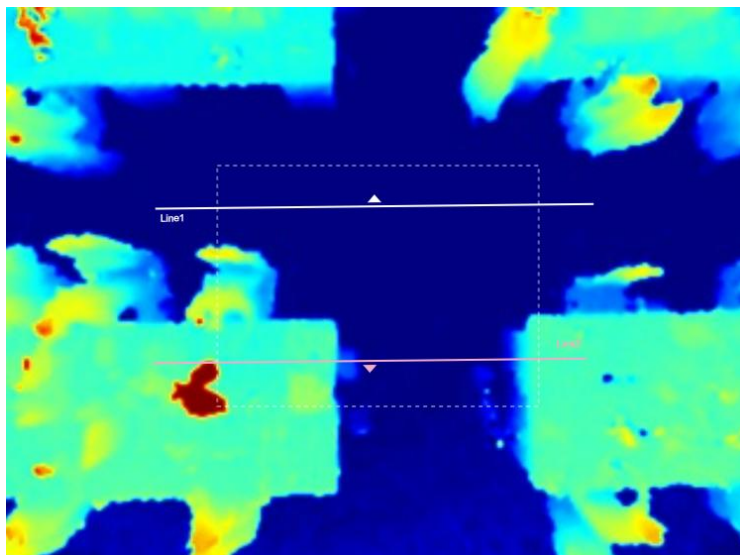

Note:

1) The arrow direction of the detection line depends on your drawing direction. If users need to flip the line, select the line which need to be flipped and click Flip Arrow Direction. And users can click Flip All to flip all detection lines.

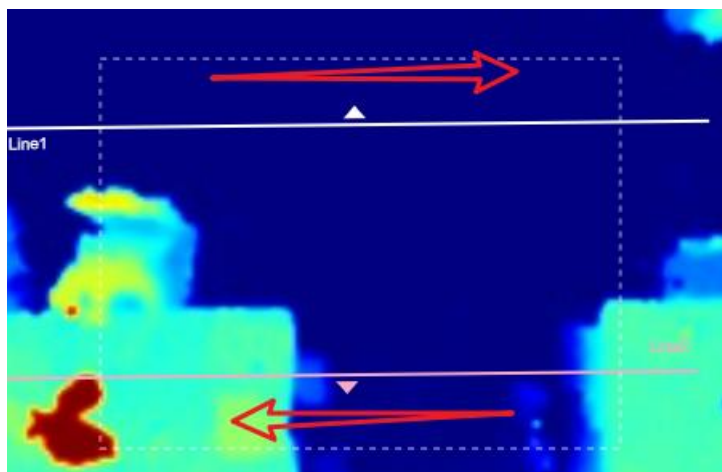

- 2) Ensure that the detected target can pass through the detection line completely. It's recommended that the detection line is perpendicular to the In/Out direction and on the center of the detection area without other objects around.
- 3) A redundant identification area needed to be left on both sides of the detection line for the target. This is to ensure that the sensor has stable recognition and tracking of this target before it passes the detection line, which will make the detection and count more accurate.

Rule Configuration

Users can set the rules to ensure accurate counting.

Deployment Parameters

Installation Height mm(2000~3500)	3000	Detect
Max. Target Height mm(500~3000)	2000	
Min. Target Height mm(500~3000)	1000	

✕ ✓

Deployment Parameters

Installation Height
mm(2000-3500) Detect

Max. Target Height
mm(500-3000)

Min. Target Height
mm(500-3000)

✕ ✓

Counting Strategy

Tracking Mode ⓘ Heads Tracking Feet Tracking

Line Cross Counting

No.	Line Name	Operation
No.1	Line1	 ⓘ

U-turn Filtering

Draw U-turn Areas ⓘ Draw

Children Distinction

Staff Detection ⓘ

Group Counting

Parameters	Description
Installation Height	<p>Set the device installation height. Click Detect to detect the current installation height automatically.</p> <p>Note:</p> <ol style="list-style-type: none"> 1) Ensure that there are no objects directly below the device avoiding interfering the height detection. 2) The automatic detection of the installation height is not supported with dark floor/carpet (black, grey, etc.)
Max. Target Height	Set the maximum target height, then the device will ignore the objects higher than this setting value.
Min. Target Height	Set the minimum target height, then the device will ignore the object shorter than this setting value.
Tracking Mode	<p>Select the tracking mode of counting, including Heads Tracking and Feet Tracking.</p> <p>Note: It is recommended to use heads tracking mode when the installation height is low in standalone working mode.</p>
U-turns Filtering	When enabled, it allows to draw an area for every line and the device will count the In and Out values only when people pass this area. Users can left-click to start the drawing and add edges for this area, then right-click to stop drawing.

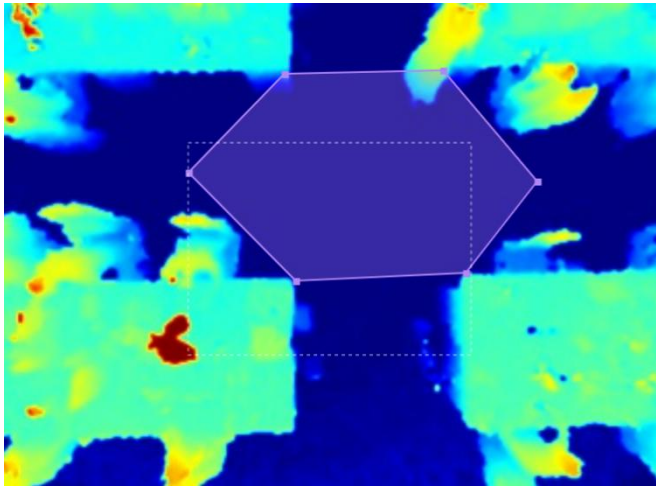
<p>Children Distinction</p>	<p>The device will detect the people shorter than child filter height as children.</p>
<p>Staff Detection</p>	<p>The device will detect the people who wear reflective stripes as staff tags on the visible parts (neck, shoulders, etc.) as staffs. Reflective stripe requirements: width > 2cm, 500 cd/lux.m²</p>
<p>Group Counting</p>	<p>Click to enable the group counting function that based on the distance, moving direction and speed difference to gain deeper insights into customer' behaviors. Note: 1) This function is only applicable for line cross people counting. 2) Only report group counting data when group counting function is enabled.</p>
<p>Region Monitoring</p>	<p>Click "+Add" to add the region monitoring. Up to 4 regions are supported with maximum 10 segments each. Step 1: Draw the region monitoring areas on the screen.</p>  <p>Step 2: You can customize the zone name. And click to enable Region People Counting and Dwell Time Detection as needed. Pass-by Filtering can be set to improve statistical accuracy and Min.Dwell Time can be set to improve statistical validity.</p> <div data-bbox="443 1478 1109 2016" style="border: 1px solid #ccc; padding: 10px;"> <p>Advanced Properties</p> <p>Zone Name <input type="text" value="Region1"/></p> <p>Region People Counting <input checked="" type="checkbox"/></p> <p>Pass-by Filtering <input type="text" value="5"/> <small>s(0~3600)</small></p> <p>Dwell Time Detection <input checked="" type="checkbox"/></p> <p>Min. Dwell Time <input type="text" value="5"/> <small>s(0~3600)</small></p> <p style="text-align: right;"><input type="button" value="x"/> <input checked="" type="button" value="✓"/></p> </div>

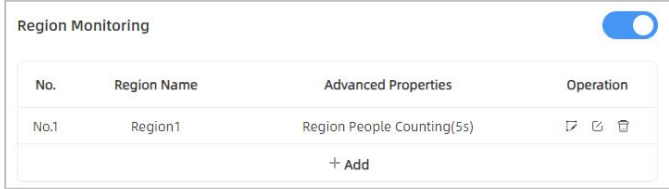
	<p>Step 3: The configuration is displayed in the list after the configuration is complete. You can redraw the areas by clicking the redraw button in the list. And click the edit button to modify the advanced settings of the areas or click delete button to delete the areas separately.</p> 
Reset Cumulative Count on Schedule	<p>Enable to periodically reset cumulative count on schedule. Cumulative Count includes: Total In/Out counting of each detection line. Max./Avg. Dwell Time of each detection region.</p>
Periodic Report	Report the people counting data periodically.
Period	Set the period of reporting periodic report. Range: 1-1080 mins, default: 10 mins

Note:

Due to the error in ToF distance measurement (0.035 m), the Max. Target Height should be set as maximum pedestrian height plus 0.035 m and the Min. Target Height as minimal pedestrian height minus 0.035 m in the actual applications. For example, if the pedestrian height is 1.6 m to 1.8 m, the Max. and Min. Target Height should be configured as 1.835 m and 1.565 m respectively.

5.3 Communication

5.3.1 WLAN

VS133 supports wlan feature to work as AP mode to configure device and it can not connect to other access point.

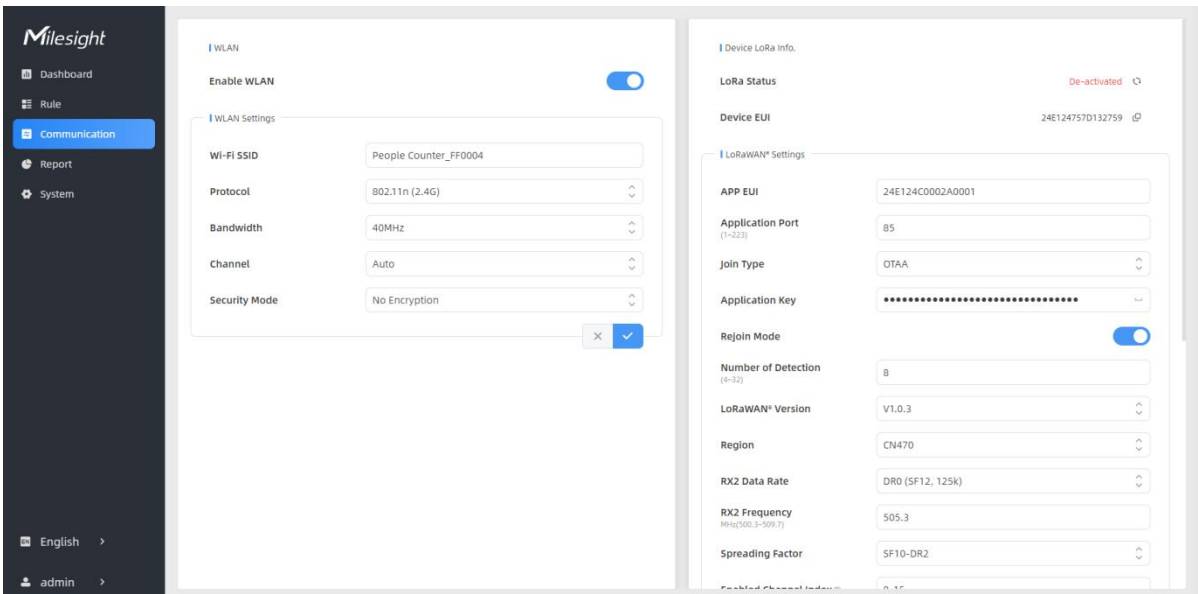



Parameters	Description
Enable WLAN	Enable or disable Wi-Fi feature. If disabled, users can use button or LoRaWAN® downlink command to enable it.
Wi-Fi SSID	The unique name for this device Wi-Fi access point.
Protocol	802.11b (2.4 GHz), 802.11g (2.4 GHz), 802.11n (2.4 GHz) are optional.
Bandwidth	20 MHz or 40 MHz are optional.
Channel	Select the wireless channel. Auto, 1,...11 are optional.
Security Mode	No Encryption, WPA-PSK, WPA2-PSK and WPA-PSK/WPA2-PSK are optional.
Cipher	AES, TKIP, AES/TKIP are optional.
Wi-Fi Password	Customize the password when security mode is not No Encryption.

5.3.2 LoRa

LoRa settings are used for configuring the transmission parameters in LoRaWAN® network.

Device LoRa Info.

LoRa Status De-activated 

Device EUI 24E1246936202833 

LoRaWAN® Settings

APP EUI

Application Port (1~223)

Join Type ^
v

Application Key ..

Rejoin Mode

Number of Detection (4~32)

LoRaWAN® Version ^
v

Region ^
v

RX2 Data Rate ^
v

RX2 Frequency MHz(923.3~927.5)

Spreading Factor ^
v

Enabled Channel Index [Ⓢ]

Channel List

Index	Frequency MHz
0-15	902.3-905.3
16-31	905.5-908.5
32-47	908.7-911.7
48-63	911.9-914.9
64-71	903-914.2

x
✓

LoRa Working Mode

Confirm Mode

ADR

Parameters	Description
LoRa Status	LoRaWAN® network joining status of this device.
Device EUI	Unique ID of the device, which can also be found on the label.
App EUI	The Default App EUI is 24E124C0002A0001.
Application Port	The port used for sending and receiving data, default port is 85.
Join Type	OTAA and ABP mode are available.
Application Key	Appkey for OTAA mode, the default key is 5572404C696E6B4C6F52613230313823.
Device Address	DevAddr for ABP mode, the default address is the 5 th to 12 th digits of SN.
Network Session Key	Nwkskey for ABP mode, the default key is 5572404C696E6B4C6F52613230313823.
Application Session Key	Appskey for ABP mode, the default key is 5572404C696E6B4C6F52613230313823.
Rejoin Mode	<p>Reporting interval \leq 35 mins: the device will send a specific number of LinkCheckReq MAC packets to the network server every reporting interval or every double reporting interval to validate connectivity; If there is no response, the device will re-join the network.</p> <p>Reporting interval $>$ 35 mins: the device will send a specific number of LinkCheckReq MAC packets to the network server every reporting interval to validate connectivity; If there is no response, the device will re-join the network.</p>

Number of Detection	When rejoin mode is enabled, set the number of detection. Note: the actual sending number is Number of Detection + 1 .
LoRaWAN® Version	V1.0.2, V1.0.3 are available.
Region	Frequency plan of this device.
RX2 Data Rate	RX2 data rate to receive downlinks.
RX2 Frequency	RX2 frequency to receive downlinks.
Spreading Factor	If ADR is disabled, the device will send data via this spreading factor.
Channel	Select the channel from channel list or enter the index to select the frequency channel. Index examples: 1, 40: Enabling Channel 1 and Channel 40 1-40: Enabling Channel 1 to Channel 40 1-40, 60: Enabling Channel 1 to Channel 40 and Channel 60 All: Enabling all channels Null: Indicates that all channels are disabled
Confirm Mode	If the device does not receive ACK packet from network server, it will resend data once.
ADR	Allow network server to adjust data rate of the device.

Note:

- 1) Please contact sales for device EUI list if there are many units.
- 2) Please contact sales if you need random App keys before purchase.
- 3) Only OTAA mode supports rejoin mode.
- 4) Select OTAA mode when you connect device to Milesight IoT Cloud.

5.4 Report

VS133 supports to generate visual line chart or bar chart to display the people traffic and supports to export the report. Before using this feature, **ensure that the device time is correct on System page.**

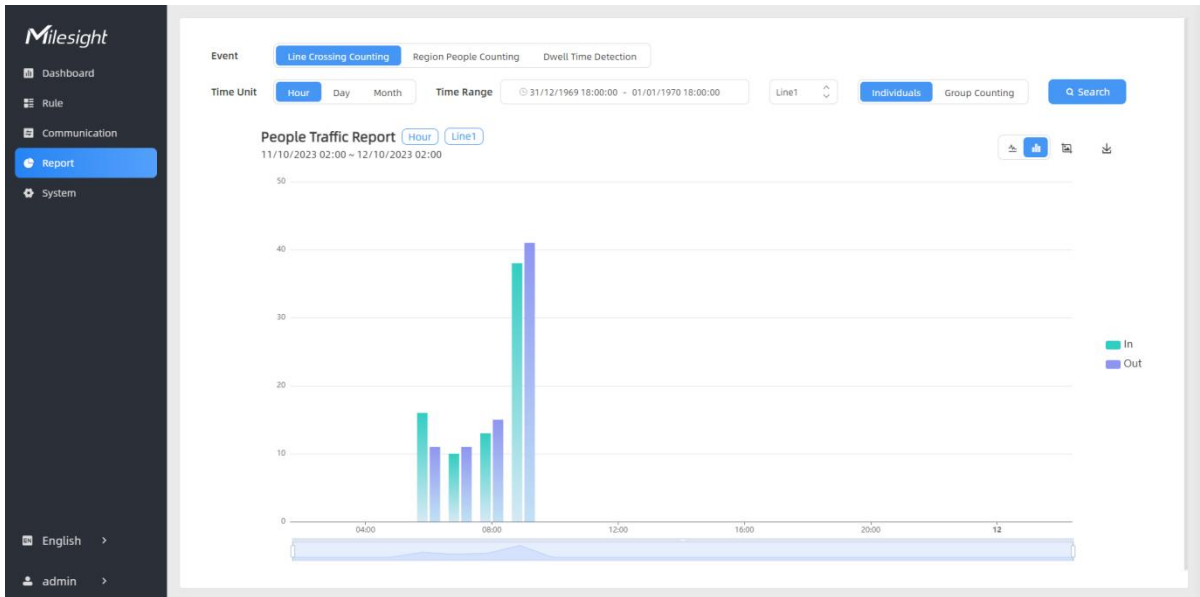

Parameters	Description
Event	Select the event which you want to query the report. Line crossing counting, region people counting and dwell time detection are optional.
Time Unit	Select the unit to generate the graph or export the data.
Time Range	Select the time range to generate the graph.
Line1	Select the line to display the graph.
Individuals Groups	Select the individuals counting reports or groups counting reports.
Region1	Select the region to display the graph.
Search	Click to generate the graph according to the time range and line option.
Export	Export the historical traffic data as CSV file according to the selected time unit. The device can store up to one million data records to CSV file.
Staff Included/Excluded	Select whether to contain staff counting values on the graph.
Line Bar	Select the display type as line or bar.
Download	Download the graph screenshot.

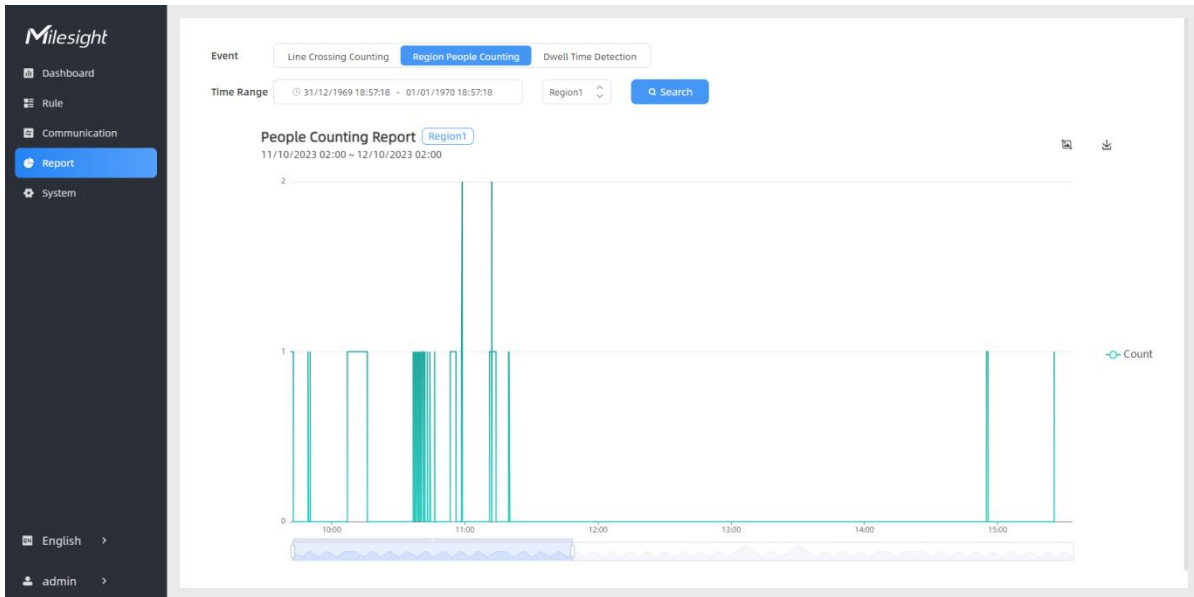

5.5 Validation







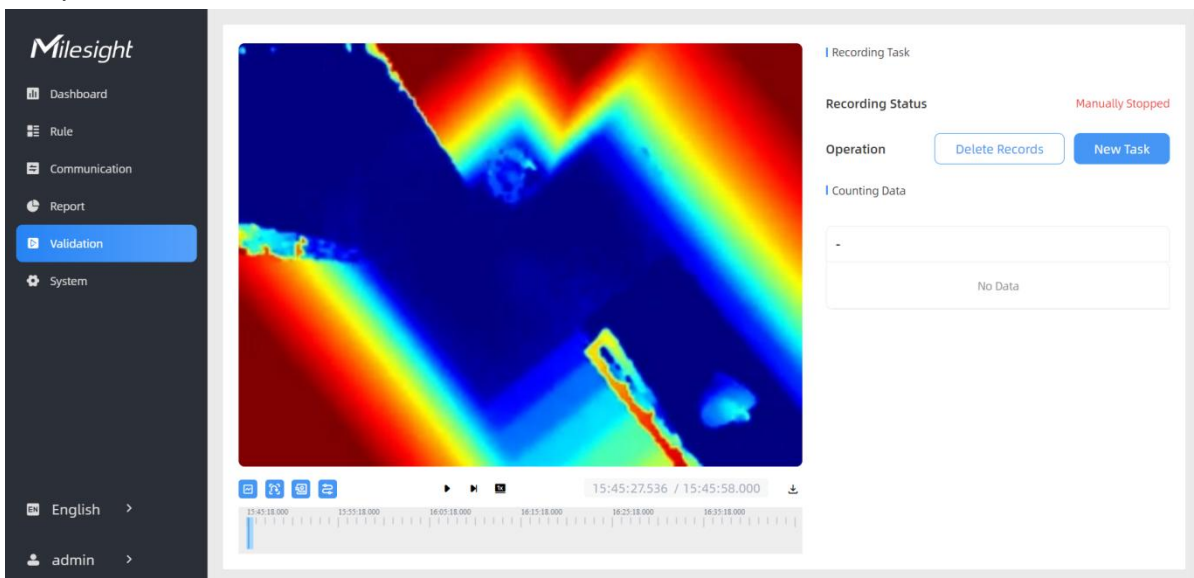

Video validation function can assist users in verifying the accuracy of people counting by setting up a video task of recording.

Note:

- Only one video task can be performed at a time, please delete the previous task before creating a new one.
- Detection rules and ToF frequency parameters cannot be modified during the recording process.

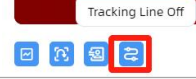

Parameters		Description
Video Task	Start Recording	Clicking Start Recording to initiate the recording task. You can manually click Stop Recording to end the recording, or it will automatically stop when the recording time reaches 60 minutes.
	Set a Task of	Configure the start time and duration of the recording. The

	Recording	duration can be set from 1 to 60 minutes. Clicking Cancel Task manually will cancel the recording schedule.
		
Playback Button		Enable/Disable detection lines in the recording footage.
		Enable/Disable u-turn area in the recording footage.
		Enable/Disable detection region in the recording footage.
		Enable/Disable tracking line in the recording footage.
		Rewind/Pause/Play/Forward(supports switching between 0.5x, 1x, 2x, and 4x playback speed).
		Start time and end time of the recording.
		Download video stream footage.

5.6 System



5.6.1 Device Info



All information about the hardware and software can be checked on this page.

Device Info.

Device Name	People Counter	<input type="text" value="x"/> <input checked="" type="checkbox"/>
Product Model	VS133-915M	
SN	6757D13928710005	
Hardware Version	V1.0	
Software Version	V_133.1.0.1-b-t14	
MAC Address	24:E1:24:FF:00:04	

5.6.2 User

Users		
Username	User Level	Operation
admin	Administrator	 
+ Add User		

Parameters	Description
	<p>You can change the login password of this device.</p> <div style="border: 1px solid #ccc; padding: 10px; margin: 10px 0;"> <p>Users modify</p> <p>Username: <input type="text" value="admin"/></p> <p>User Level: <input type="text" value="Administrator"/></p> <p>Administrator Password: <input type="password"/></p> <p>New Password: <input type="password"/></p> <p>Confirm: <input type="password"/></p> <p>At least:</p> <ul style="list-style-type: none"> 8 characters 2 types of characters: Number, letter and symbol <p style="text-align: right;"><input type="button" value="x"/> <input type="button" value="✓"/></p> </div>
	<p>Click to set three security questions for your device. In case that you forget the password, you can click Forget Password button on login page to reset the password by answering three security questions correctly.</p> <div style="border: 1px solid #ccc; padding: 10px; margin: 10px 0;"> <p>Secure Question Settings (Already Set)</p> <p>Password: <input type="password"/></p> <p>Security Question1: <input type="text" value="What is your lucky number?"/></p> <p>Answer1: <input type="text"/></p> <p>Security Question2: <input type="text" value="What is your favorite sport?"/></p> <p>Answer2: <input type="text"/></p> <p>Security Question3: <input type="text" value="What is your favorite game?"/></p> <p>Answer3: <input type="text"/></p> <p style="text-align: right;"><input type="button" value="x"/> <input type="button" value="✓"/></p> </div>
+ Add User	Click to add a viewer, who will only have access to the "Dashboard" and "Report" interfaces.

Add User

Username

User Level

Password

Confirm

At least:

- 8 characters
- 2 types of characters: Number, letter and symbol

5.6.3 Time Configuration

Current System Time

Date 01/08/2023

Time 05:36:15

Set the System Time

Time Zone

Daylight Saving Time

Start Time

End Time

DST Bias min

Synchronize Time

Setting Time

Synchronize with your computer time

Parameters	Description
Time Zone	Choose the time zone for your location.
Daylight Saving Time	Enable or disable Daylight Saving Time (DST).
Start Time	Start Time: the start time of DST time range.

	<p>End Time: the end time of DST time range.</p> <p>DST Bias: the DST time will be faster according to this bias setting.</p>
Setting Time	Set the device time manually.
Synchronize with computer time	Synchronize the time with your computer.

5.6.4 System Maintenance

Time of Flight Advanced Settings

Frequency Adjustment

Reset

Recovery device basic configuration

Recovery device to factory settings

Reboot

Reboot the Device

Upgrade

Software Version V_133.1.0.3-r2-a1

Upgrade Image

Explanation: The upgrade process takes 1-10 minutes, do not turn off the power. The automatic reboot will happen once the upgrade complete.

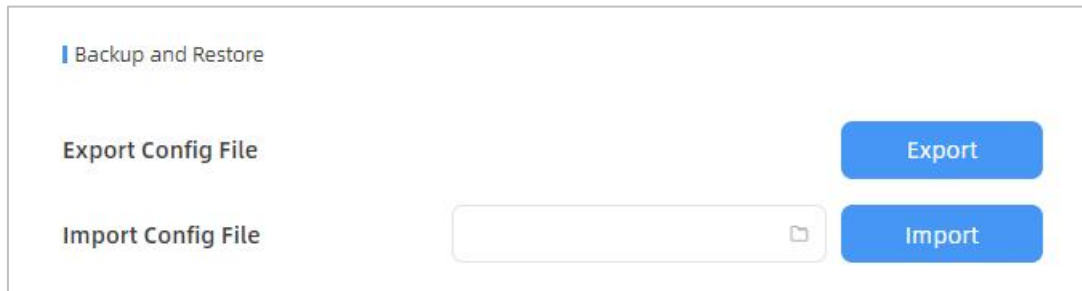

Parameters	Description
Frequency Adjustment	Adjust the ToF frequency modulation mode to avoid the interference of surrounding IR devices. Please avoid using the same mode if there are multiple VS133 devices around. Note: if there is only one option, please contact Milesight IoT support: iot.support@milesight.com
Reset	Recovery device basic configuration: keep the IP settings and user information when resetting. Recovery device to factory settings: reset device to factory default, which needs to verify admin password.
Reboot	Restart the device immediately.
Upgrade	Click the folder icon and select the upgrading file, then click the Upgrade button to upgrade. The update is done when the system reboots successfully. Note: The upgrade process takes about 1-10 minutes. Do not turn off the power and complete automatic restart after the upgrade.
Backup and Restore	Export Config File: Export configuration file. Import Config File: Click the file icon and select the configuration file, click Import button to import configuration file.

6. Installation Instruction

Parameter definition:

Parameters	Explanation	Value
H	Installation height	≤ 3.5 m
d	Minimum detection distance of VS133	0.5 m
Δd	Distance measurement error of VS133	0.035 m
h_{\max}	Maximum pedestrian height	Example 1.8 m
h_{\min}	Minimum pedestrian height	Example 1.7 m
α	ToF horizontal field of view angle	98°
β	ToF vertical field of view angle	80°
x	Length of detection range	
y	Width of detection range	

6.1 Installation Height

The maximum installation height is 3.5 m and the minimum installation height is $h_{\max}+d+\Delta d$. For

example, when the maximum pedestrian height is 1.8 m, then the minimum installation height is $1.8+0.5+0.035=2.335$ m.

6.2 Covered Detection Area

The detection area covered by the device is related to the field of view angle of the device, the installation height and the target height. The length of the detection area is approximately $x=2.300 \times (H-h_{\min})$ and the width of the detection area is approximately $y=1.678 \times (H-h_{\min})$.

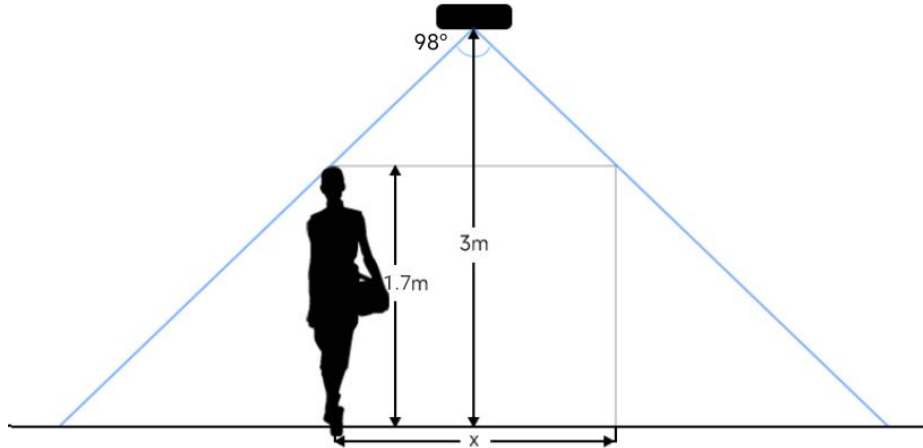

For example, if the Minimum height of pedestrians is 1.7 m, the detection area corresponding to each installation height is as follows:

Installation Height	FoV Monitored Area (m)	Detection Area (m)
2.5	5.75 × 4.20	1.84 × 1.34
2.6	5.98 × 4.36	2.07 × 1.51
2.7	6.21 × 4.53	2.30 × 1.68
2.8	6.44 × 4.70	2.53 × 1.85
2.9	6.67 × 4.87	2.76 × 2.01
3.0	6.90 × 5.03	2.99 × 2.18
3.1	7.13 × 5.20	3.22 × 2.35
3.2	7.36 × 5.37	3.45 × 2.52
3.3	7.59 × 5.54	3.68 × 2.69
3.4	7.82 × 5.71	3.91 × 2.85
3.5	8.05 × 5.87	4.14 × 3.02

6.3 Environment Requirements

- Dark floor/carpet (black, grey, etc.) will affect the device to count staffs when Staff Detection is enabled.

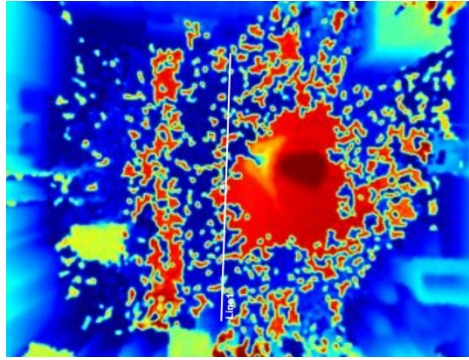

- Avoid 940nm light which may result in incorrect counting.
- Outdoor sunlight shining on the over channel will not have any effect, but the mirrored reflections that allow sunlight to shine on the ToF Sensor should be avoided.
- **When the carpet/floor is black, make sure there are no obstacles within a 60cm hemisphere range in the direction of the device. Otherwise, the device imaging may appear abnormally red.**

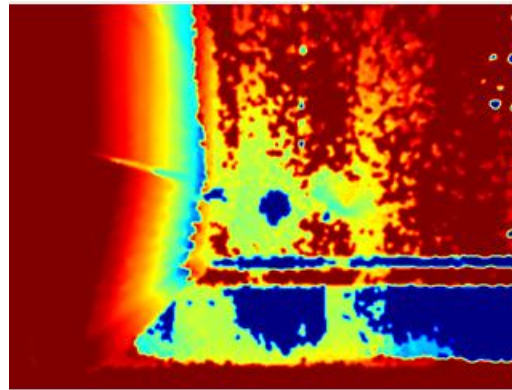
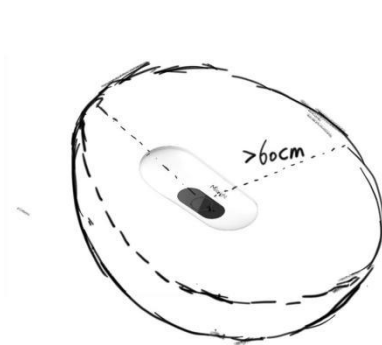

6.4 Installation

Ceiling Mount

Step 1: Ensure the thickness of the ceiling is more than 30 mm, then attach the mounting sticker to the ceiling and drill 4 holes with a diameter of 6mm. If the wire needs to be extended to the interior of the ceiling, a wire hole with a suitable size is also required to be drilled.

Step 2: Fix the wall plugs into the ceiling holes.

Step 3: Remove the cover on the device, and then connect all required wires and pass them through the wire hole behind the device or block on the side of the device if the wires need to be protruded from the side of the device.

Step 4: Fix the device to the wall plugs via mounting screws; remember to adjust the mounting direction according to the detection area requirement.

Step 5: Fix the cover back to the device.

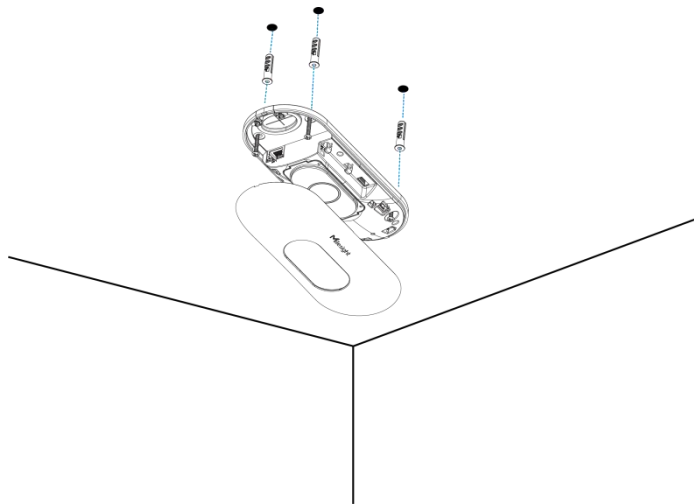

Ceiling/Lintel Mount (with Optional VB01 Multifunctional Bracket)

Step 1: Attach the mounting plate to the device with 4 screws.

Step 2: Fix the pole to the mounting plate with the hole on the plate.

Step 3: Adjust the length of the pole, then adjust the direction of 3-axis ball and tighten it with the handle.

Step 4: Determine the mounting location and drill 3 holes, fix the wall plugs into the mounting holes, then fix the bracket base to the wall plugs via mounting screws.

(Note: If the wire needs to be extended to the interior of the ceiling or wall, a wire hole with a suitable size is also required to be drilled.)

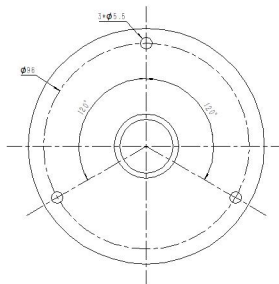

Step 5: Remove the cover on the device, and then connect all required wires and pass them through the inside of pole.

Step 6: Fix the pole to bracket base with screws and nuts.

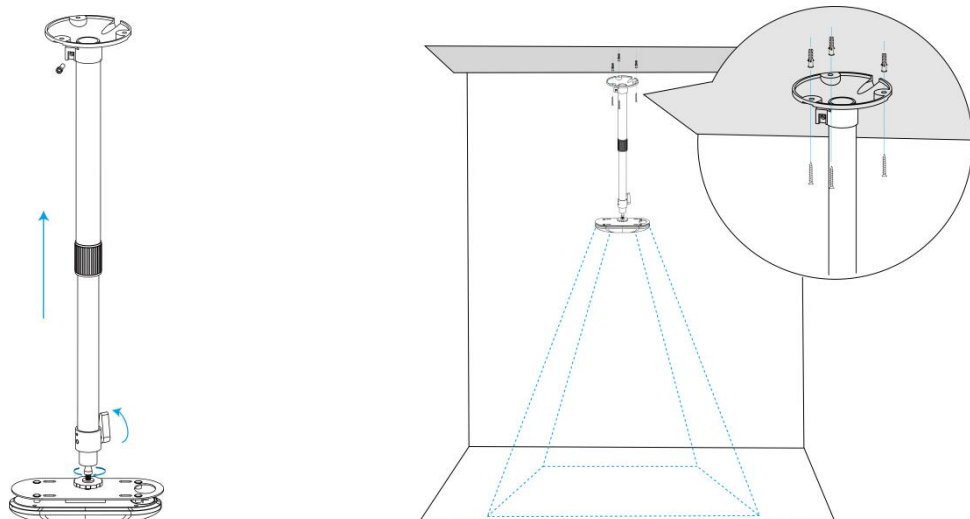

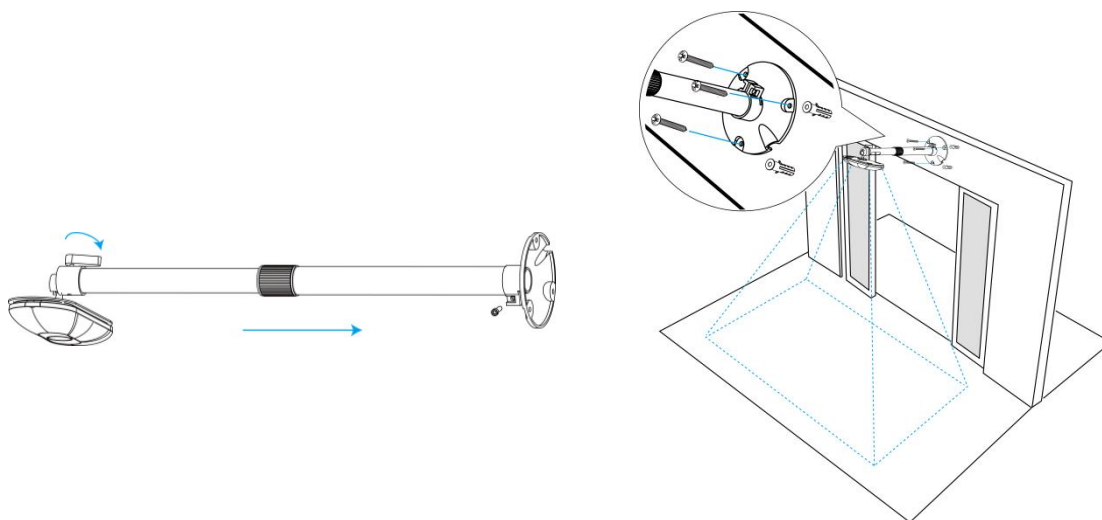

Note:

- Tilt installation should be avoided. Ensure that the front of the device and the ground plane are paralleled.
- Avoid installing the device against the wall and ensure that the device keeps away from the wall at least 30 cm on the short side and 50 cm on the long side.

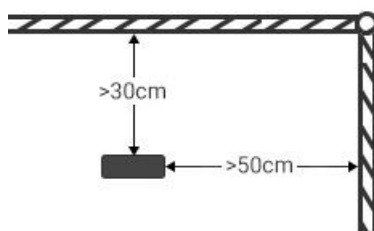

- Ensure that there are no other objects blocking the ToF light within a 30 cm radius of the front of the device.
- When you install devices on the top of swinging doors, it is suggested to keep the door normally open. If the door must be normally closed, please install the device on the other side of the door to keep away from the door movement. And it is suggested to keep away from the door with a distance of at least 30 cm.

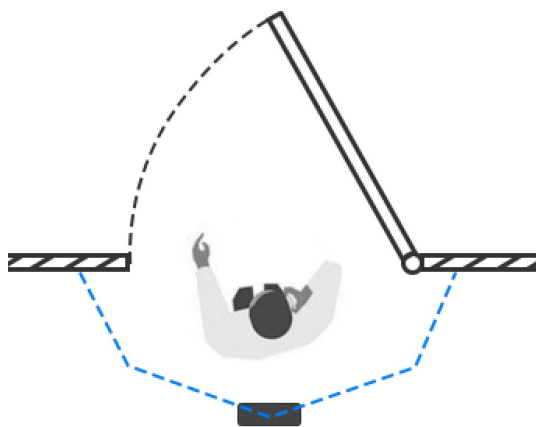

6.5 Factors Affecting Accuracy

- Wearing a fisherman's hat or carrying a cardboard box on the shoulder: The target will not be recognized because it will become unlike a human in depth map.
- Handheld or cart-carrying a humanoid doll with sufficient height to pass by: The doll will be mistakenly detected as people because it is human-like in depth map.

7. Communication Protocol

7.1 Uplink Data

VS133 reports basic information of sensor whenever joining the network and the number of people periodically. For decoder examples please find files on <https://github.com/Milesight-IoT/SensorDecoders>.

Channel	Type	Description
ff	01 (Protocol Version)	01=> V1
	09 (Hardware Version)	01 04 => V1.4
	16 (Device SN)	16 digits
	1f (Software Version)	85 01 00 05 => 133.1.0.5
03	d2 (Accumulated counter)	Line 1 accumulated in counter, 4 bytes
04	d2 (Accumulated counter)	Line 1 accumulated out counter, 4 bytes
05	cc (Periodic counter)	Line 1: Byte 1-2: in counter during the report interval Byte 3-4: out counter during the report interval
06	d2 (Accumulated counter)	Line 2 accumulated in counter, 4 bytes
07	d2 (Accumulated counter)	Line 2 accumulated out counter, 4 bytes
08	cc (Periodic counter)	Line 2: Byte 1-2: in counter during the report interval Byte 3-4: out counter during the report interval
09	d2 (Accumulated counter)	Line 3 accumulated in counter, 4 bytes
0a	d2 (Accumulated counter)	Line 3 accumulated out counter, 4 bytes
0b	cc (Periodic Counter)	Line 3: Byte 1-2: in counter during the report interval Byte 3-4: out counter during the report interval
0c	d2 (Accumulated counter)	Line 4 accumulated in counter, 4 bytes
0d	d2 (Accumulated counter)	Line 4 accumulated out counter, 4 bytes
0e	cc (Periodic Counter)	Line 4:

		Byte 1-2: in counter during the report interval Byte 3-4: out counter during the report interval
0f	e3 (Region Monitoring)	Byte 1: number of people in region 1 Byte 2: number of people in region 2 Byte 3: number of people in region 3 Byte 4: number of people in region 4
10	e4 (Region Monitoring)	Byte 1: region ID Byte 2-3: avg. dwell time Byte 4-5: max. dwell time

Note: If children distinction feature or staff detection feature is enabled, the counter uplinks will minus children and staff. For example, if children distinction is enabled, the accumulated in counter=total in counter-children in, the accumulated out counter=total out counter-children out.

Example:

1. Device information

ff0101 ff166600b09409760000 ff090102 ff1f85010001					
Channel	Type	Value	Channel	Type	Value
ff	01 (Protocol Version)	01 (V1)	ff	16(Device SN)	66 00 b0 94 09 76 00 00
Channel	Type	Value	Channel	Type	Value
ff	09 (Hardware version)	0102 (V1.2)	ff	1f (Software version)	85 01 00 01 (V133.1.0.1)

2. Line 1 People counter

03d205000000 04d203000000 05cc02000100					
Channel	Type	Value	Channel	Type	Value
03	d2 (accumulated in counter)	05 00 00 00 => 00 00 00 05=5	04	d2 (accumulated out counter)	03 00 00 00 => 00 00 00 03=3
Channel	Type	Value			
05	cc (Periodic Counter)	In: 02 00 => 00 02 = 2 Out: 01 00 => 00 01 =1			

7.2 Downlink Command

VS133 supports to configure the device via downlink commands. Application port is 85 by

default.

Channel	Type	Description
ff	10 (Reboot)	ff (Reserved)
	03 (Reporting Interval)	2 Bytes, unit: s
	04 (Confirm Mode)	00: disable, 01: enable
	05 (LoRaWAN® Channel Mask)	Byte 1: Channel index range 01: 0-15 02: 16-31 03: 32-47 04: 48-63 05: 64-79 06: 80-95 Byte 2-3: indicate disable or enable via every bit, 0=disable, 1=enable
	40 (ADR)	00: disable, 01: enable
	41 (Application Port)	1 Byte, default is 85
	42 (Wi-Fi)	00: disable, 01: enable
	43 (People Counting Periodic Report)	00: disable, 01: enable
	51 (Clear the accumulated counting)	ff (Reserved)

Note: After changing any parameter of LoRaWAN® settings, the device will re-join the network.

Example:

1. Disable Wi-Fi.

ff4200		
Channel	Type	Value
ff	42 (Wi-Fi)	00: disable

2. Set AU915 or US915 channel mask as 8-15.

ff0501ff00 ff05020000 ff05030000 ff05040000 ff05050000		
Channel	Type	Value
ff	05 (Set Channel Mask)	01: Channel index 0-15, ff00 => 8-15 is enabled 02-05: Channel index 16-79, 0000 => all disabled

3. Reboot the device.

ff10ff		
Channel	Type	Value

ff	10 (Reboot)	ff (Reserved)
----	-------------	---------------

4. Set reporting interval as 20 minutes.

ff03b004		
Channel	Type	Value
ff	03(Set Reporting Interval)	b0 04 => 04 b0 = 1200s =20 minutes

-END-