

ETSI EN 300 328 V2.2.2 (2019-07)

TEST REPORT

For

Xiamen Milesight IoT Co., Ltd.

Building C09, Software Park Phase III, Xiamen 361024, Fujian, China

Tested Model: UR35-L04EU-G-P-W
Multiple Models: UR35-L04EU-P-W, UR35-L04EU-G-W,
UR35-L04EU-W, UR35-L04EU-P-W-485,
UR35-L04EU-G-W-485, UR35-L04EU-W-485,
UR35-L04EU-G-P-W-485

Report Type: Original Report	Product Type: Industrial Cellular Router
Report Number:	XMDN220429-17582E-22B
Report Date:	2022-08-17
Reviewed By:	Rocky Xiao RF Engineer
Test Laboratory:	Bay Area Compliance Laboratories Corp. (Dongguan) No.12, Pulong East 1 st Road, Tangxia Town, Dongguan, Guangdong, China Tel: +86-769-86858888 Fax: +86-769-86858891 www.baclcorp.com.cn

TABLE OF CONTENTS

GENERAL INFORMATION	4
PRODUCT DESCRIPTION FOR EQUIPMENT UNDER TEST (EUT)	4
TECHNICAL SPECIFICATION.....	4
OBJECTIVE	4
TEST METHODOLOGY.....	4
MEASUREMENT UNCERTAINTY	5
DECLARATIONS	5
SYSTEM TEST CONFIGURATION	6
DESCRIPTION OF TEST CONFIGURATION.....	6
EQUIPMENT MODIFICATIONS.....	6
EUT EXERCISE SOFTWARE	6
SUPPORT EQUIPMENT LIST AND DETAILS.....	7
BLOCK DIAGRAM OF TEST SETUP	7
TEST EQUIPMENT LIST	8
ENVIRONMENTAL CONDITIONS	9
SUMMARY OF TEST RESULTS	10
1 – RF OUTPUT POWER	11
DEFINITION	11
LIMIT.....	11
TEST PROCEDURE.....	11
TEST DATA.....	13
2 - Power Spectral Density	14
DEFINITION	14
LIMIT.....	14
TEST PROCEDURE.....	14
TEST DATA.....	16
5 – ADAPTIVITY	23
DEFINITION	23
TEST SETUP BLOCK DIAGRAM	23
TEST PROCEDURE.....	23
TEST DATA.....	23
6 – OCCUPIED CHANNEL BANDWIDTH.....	27
DEFINITION	27
LIMIT.....	27
TEST PROCEDURE.....	27
TEST DATA.....	27
7 – TRANSMITTER UNWANTED EMISSION IN THE OUT-OF-BAND DOMAIN.....	32
DEFINITION	32
LIMIT.....	32
TEST PROCEDURE.....	32
TEST DATA.....	33
8 – TRANSMITTER UNWANTED EMISSION IN THE SPURIOUS DOMAIN.....	34
DEFINITION	34
LIMIT.....	34
TEST PROCEDURE.....	34
TEST DATA.....	35
9 – RECEIVER SPURIOUS EMISSIONS	44
DEFINITION	44
LIMIT.....	44

TEST PROCEDURE..... 44
TEST DATA..... 45
10 - Receiver Blocking 54
DEFINITION 54
LIMIT..... 54
TEST SETUP BLOCK DIAGRAM..... 56
TEST PROCEDURE..... 56
TEST DATA..... 56
EXHIBIT A - E.2 INFORMATION AS REQUIRED BY EN 300 328 V2.2.2, CLAUSE 5.4.1 57
EXHIBIT B - EUT PHOTOGRAPHS 62
EXHIBIT C – TEST SETUP PHOTOGRAPHS..... 63

GENERAL INFORMATION

Product Description for Equipment under Test (EUT)

EUT Name:		Industrial Cellular Router
EUT Model:		UR35-L04EU-G-P-W
Multiple Models:		UR35-L04EU-P-W, UR35-L04EU-G-W, UR35-L04EU-W, UR35-L04EU-P-W-485, UR35-L04EU-G-W-485, UR35-L04EU-W-485, UR35-L04EU-G-P-W-485
Model Difference:		Please refer to the DoS
Rated Input Voltage:		9-48Vdc from Adapter
Adapter Information:	Model:	2ABF060R
	Input:	100-240Vac 50/60Hz 1.7A
	Output:	48Vdc 1.25A
Serial Number:		XMDN220429-17582E-RF-S1(UR35-L04EU-G-P-W)
EUT Received Date:		2022.05.06
EUT Received Status:		Good

Technical Specification

Operation Frequency Range (MHz):		802.11b/g/n20: 2412-2472 802.11n40: 2422-2462
RF Output Power (EIRP) (dBm):		802.11 b: 17.49dBm; 802.11 g: 14.29dBm; 802.11 n20: 15.79dBm; 802.11 n40: 14.99dBm
Number of Chains	Transmit:	1
	Receive:	1
Antenna Gain (dBi)[▲]:		3.89
Modulation Type:		DSSS, OFDM

Objective

This report is prepared on behalf of *Xiamen Milesight IoT Co., Ltd.* in accordance with ETSI EN 300328 V2.2.2 (2019-07), Wideband transmission systems; Data transmission equipment operating in the 2,4 GHz band; Harmonised Standard for access to radio spectrum.

The objective is to determine the compliance of EUT with ETSI EN 300328 V2.2.2 (2019-07).

Test Methodology

All measurements contained in this report were conducted with ETSI EN 300328 V2.2.2 (2019-07).

Measurement Uncertainty

Parameter	Flab	Maximum allow uncertainty
Occupied Channel Bandwidth	±5 %	±5 %
RF output power, conducted	±0.61dB	±1,5 dB
Power Spectral Density, conducted	±3 dB	±3 dB
Unwanted Emissions, conducted	±2.47dB	±3 dB
All emissions, radiated	±3.62dB	±6 dB
Temperature	±1 °C	±3 °C
Supply voltages	±0.4%	±3 %
Duty Cycle	1%	±5 %

Note: Otherwise required by the applicant or Product Regulations, Decision Rule in this report did not consider the uncertainty. The extended uncertainty given in this report is obtained by combining the standard uncertainty times the coverage factor K with the 95% confidence interval.

Declarations

BACL is not responsible for the authenticity of any test data provided by the applicant. Data included from the applicant that may affect test results are marked with a triangle symbol “▲”. Customer model name, addresses, names, trademarks etc. are not considered data.

Unless otherwise stated the results shown in this test report refer only to the sample(s) tested.

This report cannot be reproduced except in full, without prior written approval of the Company.

This report is valid only with a valid digital signature. The digital signature may be available only under the Adobe software above version 7.0.

This report may contain data that are not covered by the accreditation scope and shall be marked with an asterisk “★”.

SYSTEM TEST CONFIGURATION

Description of Test Configuration

The system was configured for testing in engineering mode which was provided by manufacturer. 13 channels are provided to testing as below table:

Channel	Frequency (MHz)	Channel	Frequency (MHz)
1	2412	8	2447
2	2417	9	2452
3	2422	10	2457
4	2427	11	2462
5	2432	12	2467
6	2437	13	2472
7	2442	/	/

For lowest, middle and highest channel, 802.11b, 802.11g and 802.11n-HT20 modes were tested with Channel 1, 7 and 13; 802.11n-HT40 mode was tested with Channel 3, 7 and 11.

The extreme temperature test conditions which were declared by the manufacturer and the normal conditions are as below:

NT: Normal Temperature +25°C

LT: Low Temperature -40°C

HT: High Temperature +70°C

Equipment Modifications

No modification was made to the EUT tested.

EUT Exercise Software

Software "SecureCRT[▲]" was used for setting device works in engineering mode, and the maximum power level was configured as following setting, which was provided by manufacturer[▲]. The worst-case data rates are determined to be as follows for each mode based upon investigation by measuring the average power and PSD across all data rates bandwidths, and modulations.

Mode	Channel	Frequency (MHz)	Power level
802.11 b	Low	2412	55
	Middle	2442	52
	High	2472	50
802.11 g	Low	2412	45
	Middle	2442	45
	High	2472	45
802.11 n20	Low	2412	50
	Middle	2442	50
	High	2472	50
802.11 n40	Low	2422	50
	Middle	2442	50
	High	2462	48

Support Equipment List and Details

Manufacturer	Description	Model	Serial Number
/	/	/	/

Support Cable List and Details

Cable Description	Shielding Cable	Ferrite Core	Length (m)	From Port	To
DC Cable	No	No	1.5	Adapter	EUT

Block Diagram of Test Setup

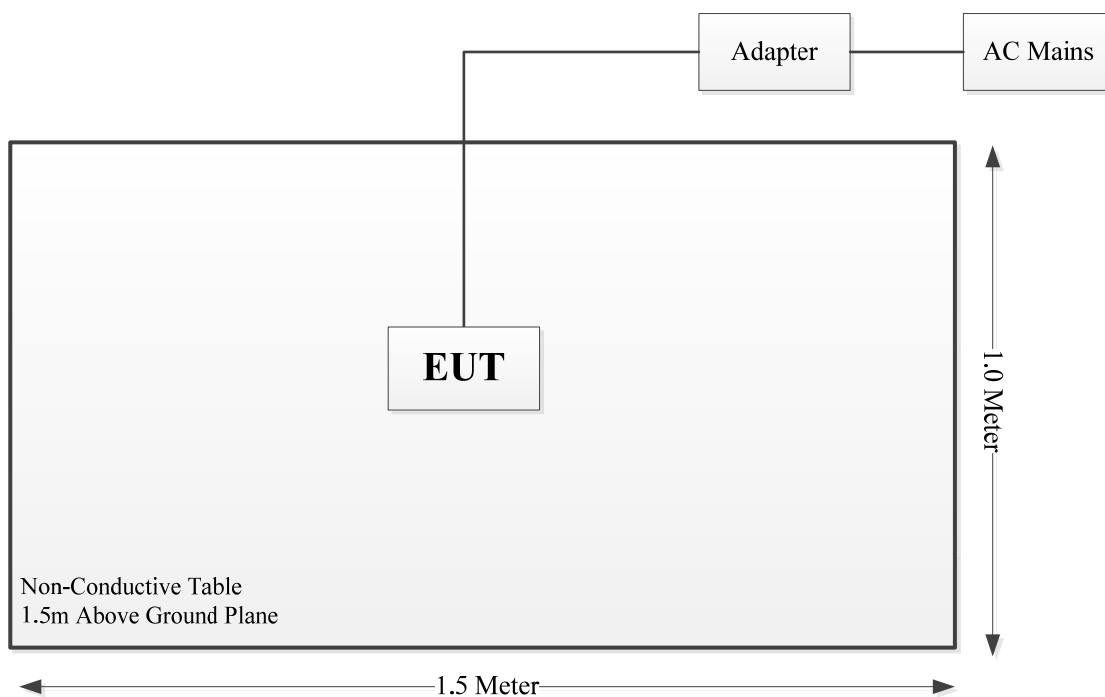

Test Equipment List

Manufacturer	Description	Model	Serial Number	Calibration Date	Calibration Due Date
Radiated emissions below 1GHz					
Sunol Sciences	Antenna	JB3	A060611-1	2020-11-10	2023-11-10
R&S	EMI Test Receiver	ESR3	102453	2021-10-26	2022-10-25
Unknown	Coaxial Cable	C-NJNJ-50	C-0075-01	2021-07-19	2022-07-18
Unknown	Coaxial Cable	C-NJNJ-50	C-0400-01	2021-07-19	2022-07-18
Unknown	Coaxial Cable	C-NJNJ-50	C-1400-01	2021-07-19	2022-07-18
Sonoma	Amplifier	310N	372193	2021-07-18	2022-07-17
EMCO	Adjustable Dipole Antenna	3121C	9109-753	N/A	N/A
Unknown	Coaxial Cable	C-NJNJ-50	C-0200-02	2021-09-04	2022-09-03
Agilent	Signal Generator	E8247C	MY43321350	2022-04-01	2023-03-31
Radiated emissions above 1 GHz					
ETS-Lindgren	Horn Antenna	3115	000 527 35	2021-10-12	2024-10-11
Agilent	Spectrum Analyzer	E4440A	SG43360054	2021-07-22	2022-07-21
Unknown	Coaxial Cable	C-SJSJ-50	C-0800-01	2021-09-04	2022-09-03
AH	Preamplifier	PAM-0118	469	2021-10-13	2022-10-12
TDK RF	Horn Antenna	HRN-0118	130 084	2021-10-12	2024-10-11
Unknown	Coaxial Cable	C-NJNJ-50	C-0200-02	2021-09-04	2022-09-03
Agilent	Signal Generator	E8247C	MY43321350	2022-04-01	2023-03-31
E-Microwave	Band-stop Filters	OBSF-2400-2483.5-S	OE01601525	2021-06-16	2022-06-15
Mini Circuits	High Pass Filter	VHF-6010+	31118	2021-06-16	2022-06-15
RF conducted					
R&S	Spectrum Analyzer	FSV40	101589	2022-07-15	2023-07-14
Unknown	Coaxial Cable	C-SJ00-0010	C0010/02	Each time	N/A
E-Microwave	Blocking Control	EMDCB-00036	OE01201048	2022-05-06	2023-05-05
E-Microwave	Coaxial Attenuators	EMCA10-5RN-6	OE01203239	2021-09-04	2022-09-03
Agilent	USB Wideband Power Sensor	U2021XA	MY54250009	2022-07-21	2023-07-20
R&S	Wideband Radio Communication Tester	CMW500	149216	2022-04-01	2023-03-31
BACL	TEMP&HUMI Test Chamber	BTH-150	30022	2022-02-24	2023-02-23
Keysight	MXA Signal Analyzer	N9020	MY48490137	2021-10-26	2022-10-25
Agilent	MXG Analog Signal Generator	N5181A	MY48180151	2021-10-26	2022-10-25
Agilent	MXG Vector Signal Generator	N5182A	MY49060274	2021-10-26	2022-10-25
Tonscend	RF Control Unit	JS0806-2	19G8060171	2021-10-26	2022-10-25

* Statement of Traceability: Bay Area Compliance Laboratories Corp. (Dongguan) attests that all calibrations have been performed, traceable to National Primary Standards and International System of Units (SI).

Environmental Conditions

Test Site:	Radiated emissions	RF conducted
Temperature:	22.9~23.4°C	24.1~25.3°C
Relative Humidity:	49~59%	45~65%
ATM Pressure:	100.9kPa	99.9~100.2kPa
Tester:	Leo Yuan, Bill Yang	Claire Liu
Test Date:	2022-05-17	2022-08-08~2022-08-17

SUMMARY OF TEST RESULTS

SN	Rule and Clause	Description of Test	Test Result
1	EN 300 328 Clause 4.3.2.2	RF output power	Compliant
2	EN 300 328 Clause 4.3.2.3	Power Spectral Density	Compliant
3	EN 300 328 Clause 4.3.2.4	Duty cycle, Tx-Sequence, Tx-gap	Not applicable*
4	EN 300 328 Clause 4.3.2.5	Medium Utilisation (MU) factor	Not applicable*
5	EN 300 328 Clause 4.3.2.6	Adaptivity	Compliant
6	EN 300 328 Clause 4.3.2.7	Occupied Channel Bandwidth	Compliant
7	EN 300 328 Clause 4.3.2.8	Transmitter unwanted emissions in the out-of-band domain	Compliant
8	EN 300 328 Clause 4.3.2.9	Transmitter unwanted emissions in the spurious domain	Compliant
9	EN 300 328 Clause 4.3.2.10	Receiver spurious emissions	Compliant
10	EN 300 328 Clause 4.3.2.11	Receiver Blocking	Compliant
11	EN 300 328 Clause 4.3.2.12	Geo-location capability	Not applicable**

Note:

The applicant declared that the equipment is adaptive equipment.

Not applicable*: The test is not applicable for adaptive equipment.

Not applicable**: The manufacturer declared the device without Geo-location capability.

1 – RF OUTPUT POWER

Definition

The RF output power is defined as the mean equivalent isotropic radiated power (e.i.r.p.) of the equipment during a transmission burst.

Limit

The RF output power for non-FHSS equipment shall be equal to or less than 20 dBm.

For Non-adaptive FHSS equipment, the manufacturer may have declared a reduced RF Output Power (see clause 5.4.1 m)) and associated Duty Cycle (see clause 5.4.1 e)) that will ensure that the equipment meets the requirement for the Medium Utilization (MU) factor further described in clause 4.3.2.5. This is verified by the conformance test referred to in clause 4.3.2.5.4.

For non-adaptive non-FHSS equipment, where the manufacturer has declared an RF output power of less than 20 dBm e.i.r.p., the RF output power shall be equal to or less than that declared value.

This limit shall apply for any combination of power level and intended antenna assembly.

Test Procedure

The test procedure shall be as follows:

Step 1:

- Use a fast power sensor suitable for 2,4 GHz and capable of minimum 1 MS/s.
 - Use the following settings:
 - Sample speed 1 MS/s or faster.
 - The samples shall represent the RMS power of the signal.
 - Measurement duration: For non-adaptive equipment: equal to the observation period defined in clause 4.3.1.3.2 or clause 4.3.2.4.2. For adaptive equipment, the measurement duration shall be long enough to ensure a minimum number of bursts (at least 10) are captured.
- For adaptive equipment, to increase the measurement accuracy, a higher number of bursts may be used.

Step 2:

- For conducted measurements on devices with one transmit chain:
 - Connect the power sensor to the transmit port, sample the transmit signal and store the raw data. Use these stored samples in all following steps.
- For conducted measurements on devices with multiple transmit chains:
 - Connect one power sensor to each transmit port for a synchronous measurement on all transmit ports.
 - Trigger the power sensors so that they start sampling at the same time. Make sure the time difference between the samples of all sensors is less than 500 ns.
 - For each individual sampling point (time domain), sum the coincident power samples of all ports and store them. Use these summed samples in all following steps.

Step 3:

- Find the start and stop times of each burst in the stored measurement samples.

The start and stop times are defined as the points where the power is at least 30 dB below the highest value of the stored samples in step 2.

In case of insufficient dynamic range, the value of 30 dB may need to be reduced appropriately.

Step 4:

- Between the start and stop times of each individual burst calculate the RMS power over the burst using the formula below. The start and stop points shall be included. Save these P_{burst} values, as well as the start and stop times for each burst.

$$P_{burst} = \frac{1}{k} \sum_{n=1}^k P_{sample}(n)$$

with 'k' being the total number of samples and 'n' the actual sample number

Step 5:

- The highest of all P_{burst} values (value "A" in dBm) will be used for maximum e.i.r.p. calculations.

Step 6:

- Add the (stated) antenna assembly gain "G" in dBi of the individual antenna.
- If applicable, add the additional beamforming gain "Y" in dB.
- If more than one antenna assembly is intended for this power setting, the maximum overall antenna gain (G or G + Y) shall be used.
- The RF Output Power (P) shall be calculated using the formula below:

$$P = A + G + Y$$

- This value, which shall comply with the limit given in clause 4.3.1.2.3 or clause 4.3.2.2.3, shall be recorded in the test report.

Test Data

Test Result: Compliant. Please refer to following tables.

Mode	Channel	Conducted output power (dBm)			Result (dBm)			Limit (dBm)
		LT	NT	HT	LT	NT	HT	
802.11 b	Low	12.90	12.26	11.80	16.79	16.15	15.69	≤ 20
	Middle	12.80	12.45	11.90	16.69	16.34	15.79	
	High	13.60	13.02	12.50	17.49	16.91	16.39	
802.11 g	Low	10.40	9.72	9.30	14.29	13.61	13.19	
	Middle	10.20	9.56	9.10	14.09	13.45	12.99	
	High	10.20	9.79	9.30	14.09	13.68	13.19	
802.11 n20	Low	10.90	10.45	9.80	14.79	14.34	13.69	
	Middle	11.30	10.94	10.20	15.19	14.83	14.09	
	High	11.90	11.30	10.20	15.79	15.19	14.09	
802.11 n40	Low	11.10	10.23	9.80	14.99	14.12	13.69	
	Middle	10.60	9.74	9.20	14.49	13.63	13.09	
	High	10.60	9.72	9.10	14.49	13.61	12.99	

Note: The antenna Gain was added into the test result.

2 - POWER SPECTRAL DENSITY

Definition

The Power Spectral Density is the mean equivalent isotropically radiated power (e.i.r.p.) spectral density in a 1 MHz bandwidth during a transmission burst.

Limit

The maximum Power Spectral Density for non-FHSS equipment is 10 dBm per MHz.

Test Procedure

The transmitter shall be connected to a spectrum analyser and the Power Spectral Density as defined in clause 4.3.2.3 shall be measured and recorded.

The test procedure shall be as follows:

Step 1:

Connect the UUT to the spectrum analyser and use the following settings:

- Start Frequency: 2 400 MHz
- Stop Frequency: 2 483.5 MHz
- Resolution BW: 10 kHz
- Video BW: 30 kHz
- Sweep Points: > 8 350; for spectrum analysers not supporting this number of sweep points, the frequency band may be segmented

NOTE: For spectrum analysers not supporting this number of sweep points, the frequency band may be segmented.

- Detector: RMS
- Trace Mode: Max Hold
- Sweep time: For non-continuous transmissions: $2 \times \text{Channel Occupancy Time} \times \text{number of sweep points}$
For continuous transmissions: 10 s; the sweep time may be increased further until a value where the sweep time has no impact on the RMS value of the signal.

For non-continuous signals, wait for the trace to stabilize. Save the data (trace data) set to a file.

Step 2:

For conducted measurements on smart antenna systems using either operating mode 2 or operating mode 3 (see clause 5.3.2.2), repeat the measurement for each of the transmit ports. For each sampling point (frequency domain), add up the coincident power values (in mW) for the different transmit chains and use this as the new data set.

Step 3:

Add up the values for power for all the samples in the file using the formula below.

$$P_{Sum} = \frac{1}{k} \sum_{n=1}^k P_{sample}(n)$$

with 'k' being the total number of samples and 'n' the actual sample number

Step 4:

Normalize the individual values for power (in dBm) so that the sum is equal to the RF Output Power (e.i.r.p.) measured in clause 5.3.2 and save the corrected data. The following formulas can be used:

$$C_{Corr} = P_{Sum} - P_{e.i.r.p}$$

$$P_{Samplecorr}(n) = P_{Sample}(n) - C_{Corr}$$

with 'n' being the actual sample number

Step 5:

Starting from the first sample $P_{Samplecorr}(n)$ (lowest frequency), add up the power (in mW) of the following samples representing a 1 MHz segment and record the results for power and position (i.e. sample #1 to sample #100). This is the Power Spectral Density (e.i.r.p.) for the first 1 MHz segment which shall be recorded.

Step 6:

Shift the start point of the samples added up in step 5 by one sample and repeat the procedure in step 5 (i.e. sample #2 to sample #101).

Step 7:

Repeat step 6 until the end of the data set and record the Power Spectral Density values for each of the 1 MHz segments.

From all the recorded results, the highest value is the maximum Power Spectral Density for the UUT. This value, which shall comply with the limit given in clause 4.3.2.3.3, shall be recorded in the test report.

Test Data

Test Result: Compliant. Please refer to following tables.

Mode	Channel	Reading (dBm/MHz)	Result (dBm/MHz)	Limit (dBm/MHz)
802.11 b	Low	2.74	6.63	≤ 10
	Middle	3.07	6.96	
	High	3.58	7.47	
802.11 g	Low	-1.52	2.37	
	Middle	-1.73	2.16	
	High	-1.50	2.39	
802.11 n20	Low	-0.99	2.90	
	Middle	-0.55	3.34	
	High	-0.31	3.58	
802.11 n40	Low	-4.37	-0.48	
	Middle	-4.69	-0.80	
	High	-4.91	-1.02	

Note: The antenna Gain was added into the test result.

Please refer to following plots:

802.11 b_Low Channel

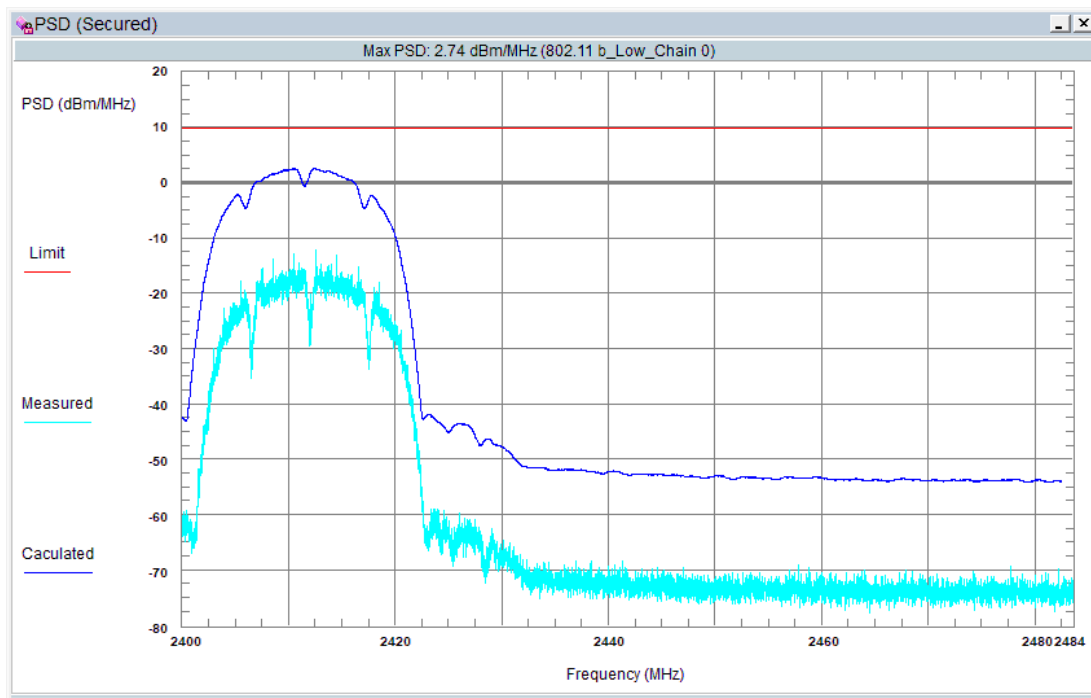

802.11 b_Middle Channel

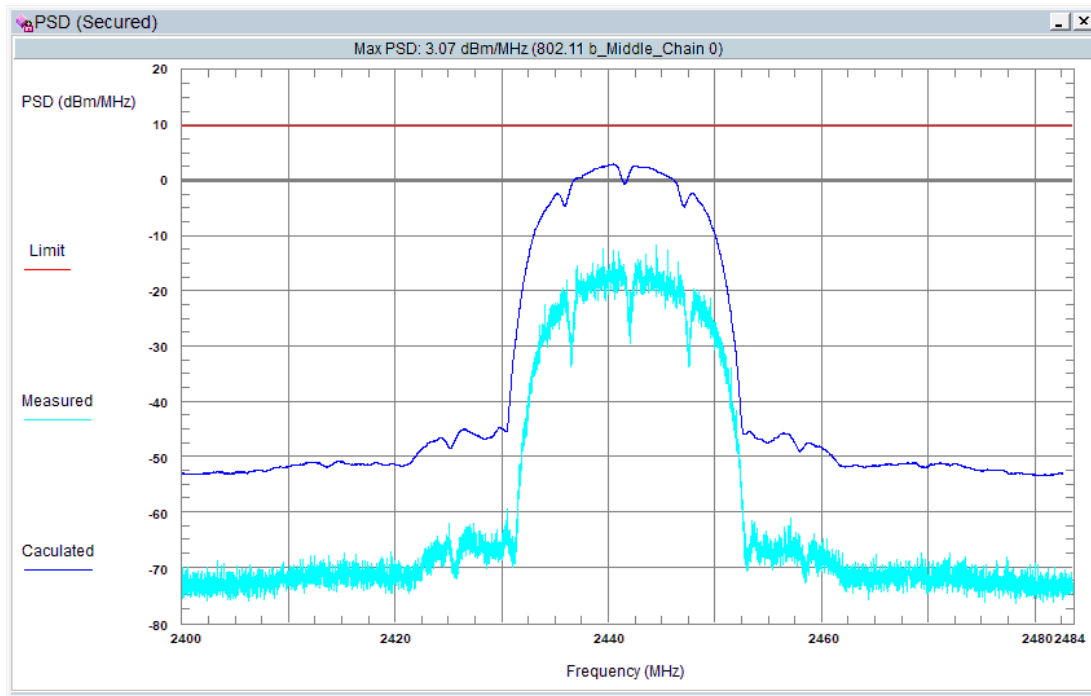

802.11 b_High Channel

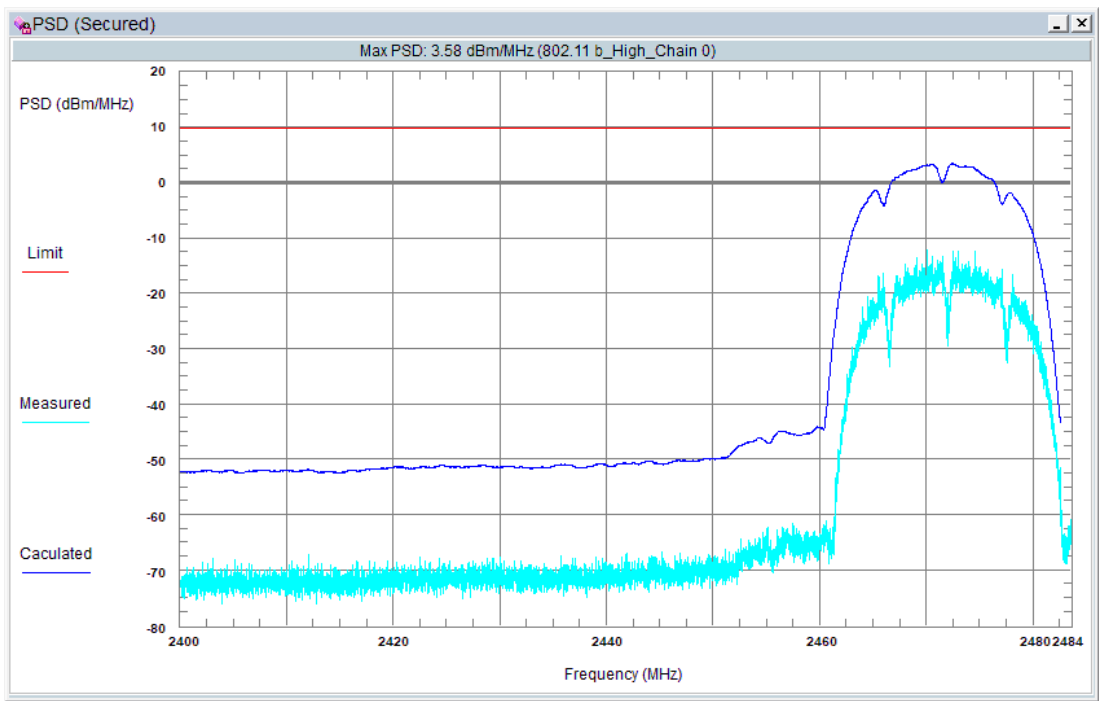

802.11 g_Low Channel

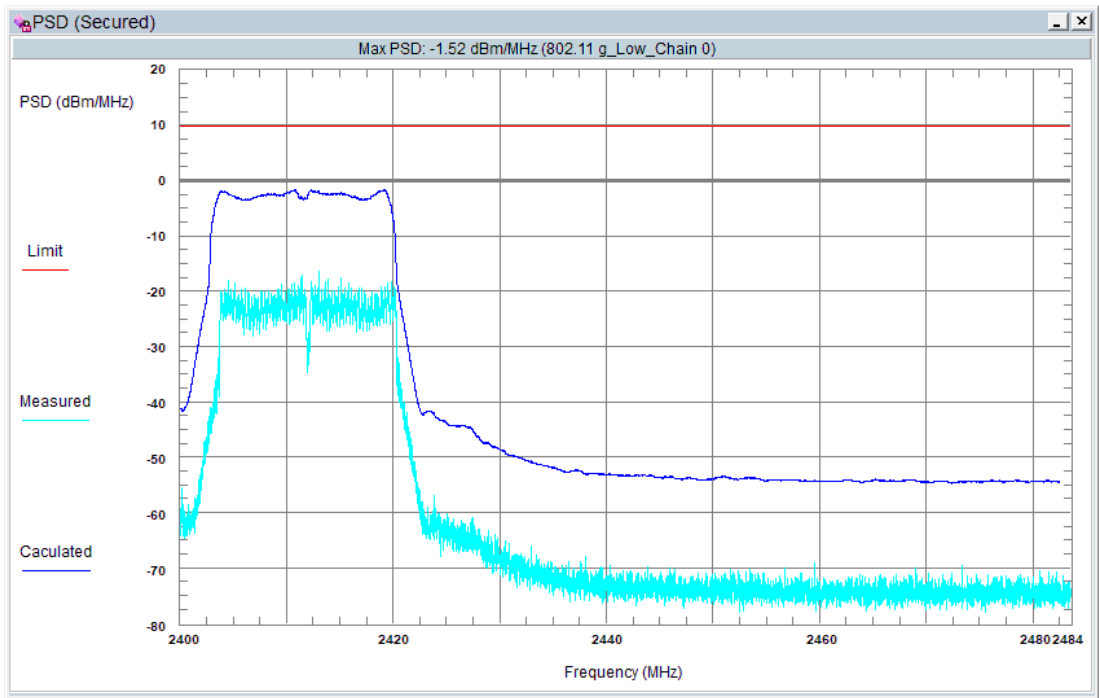

802.11 g_Middle Channel

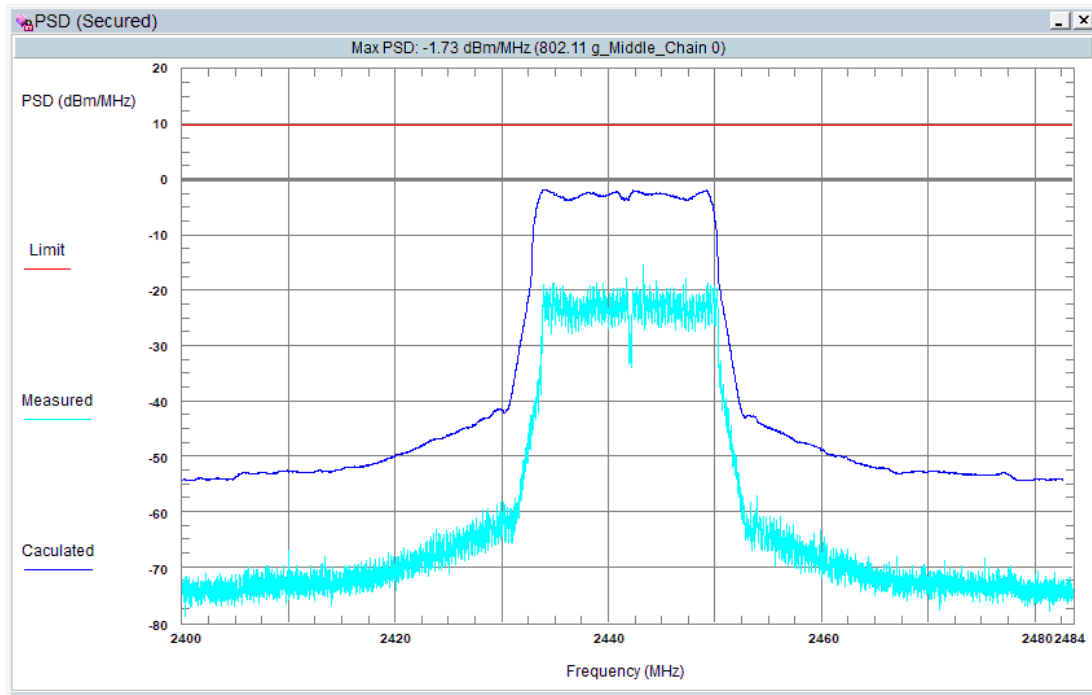

802.11 g_High Channel

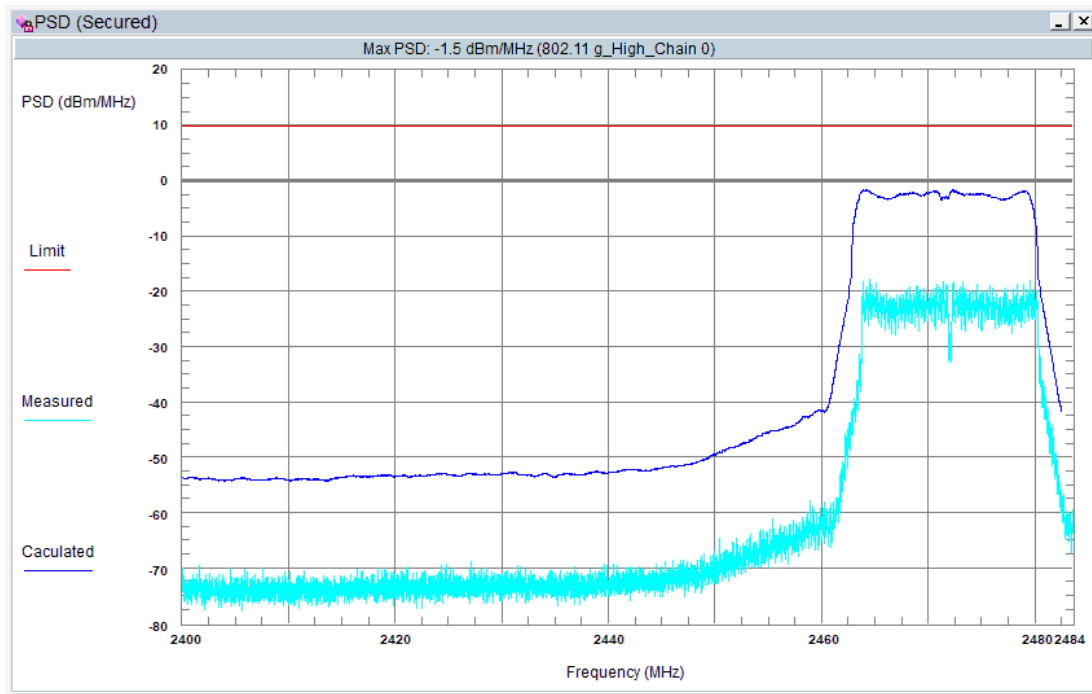

802.11 n20 Low Channel

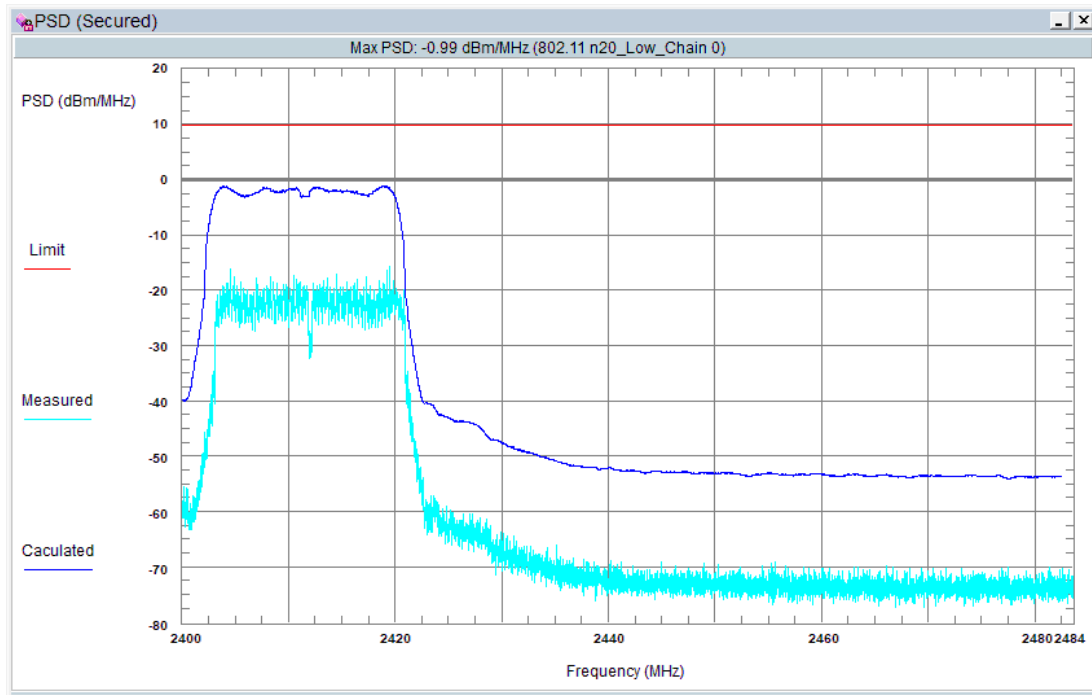

802.11 n20 Middle Channel

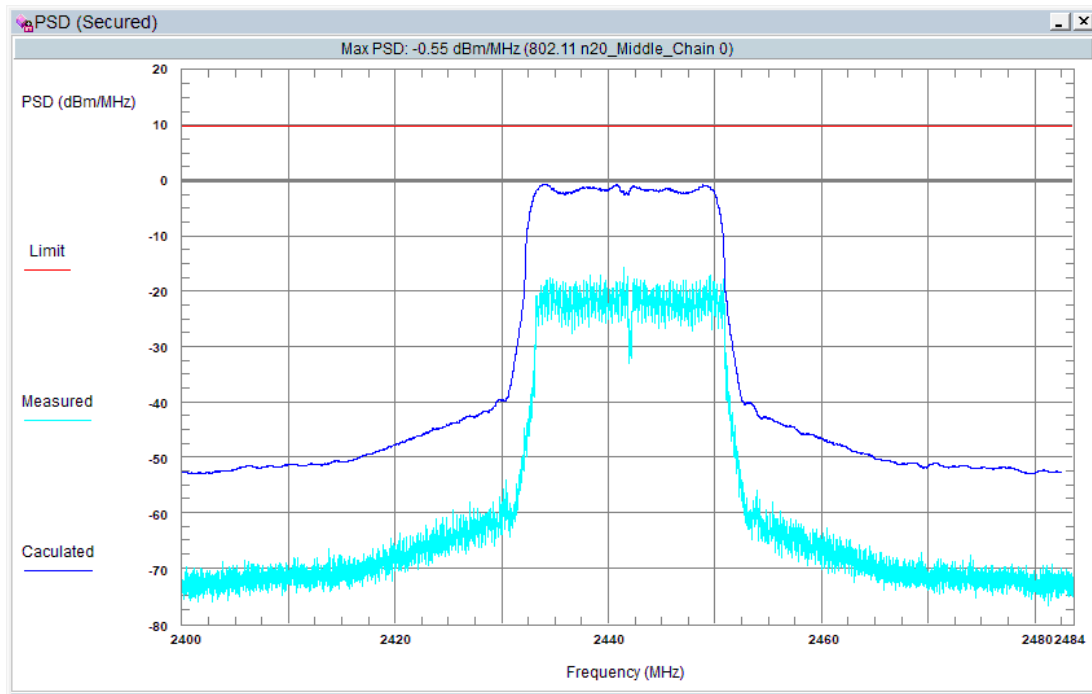

802.11 n20 High Channel

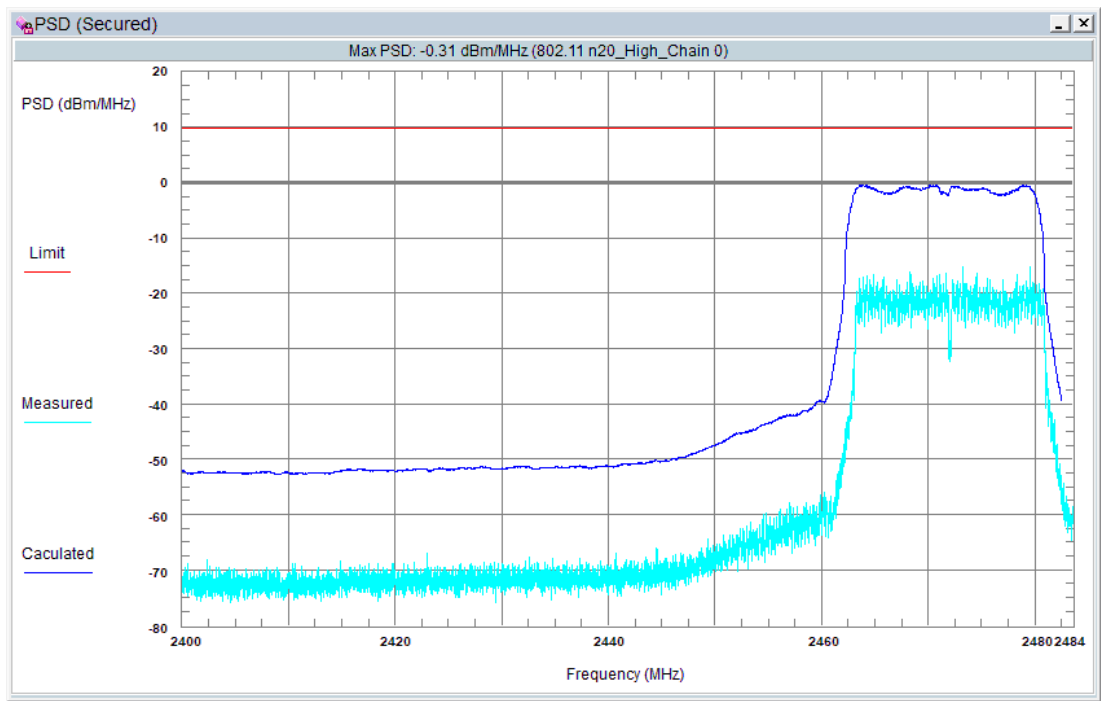

802.11 n40 Low Channel

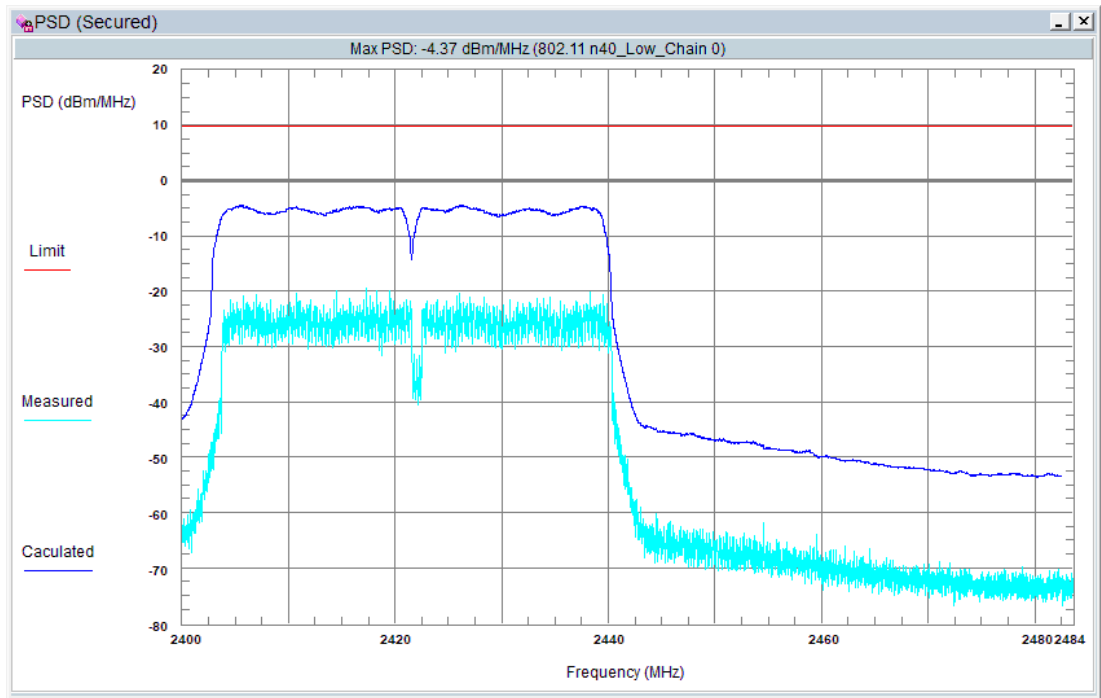

802.11 n40 Middle Channel

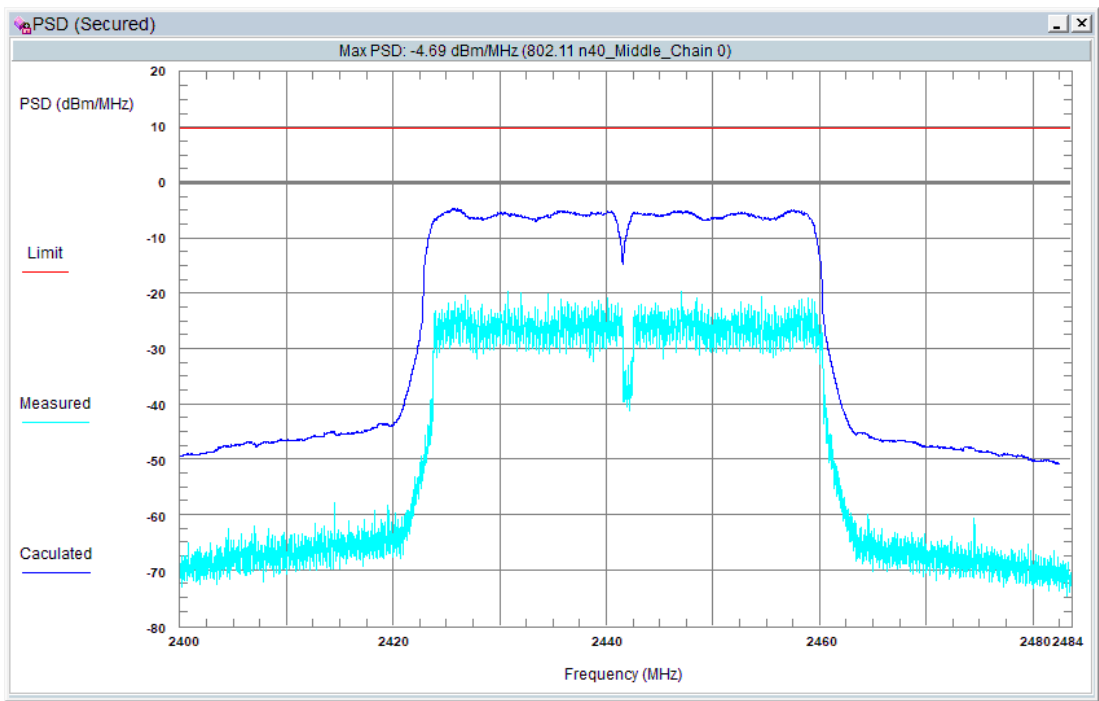

802.11 n40 High Channel

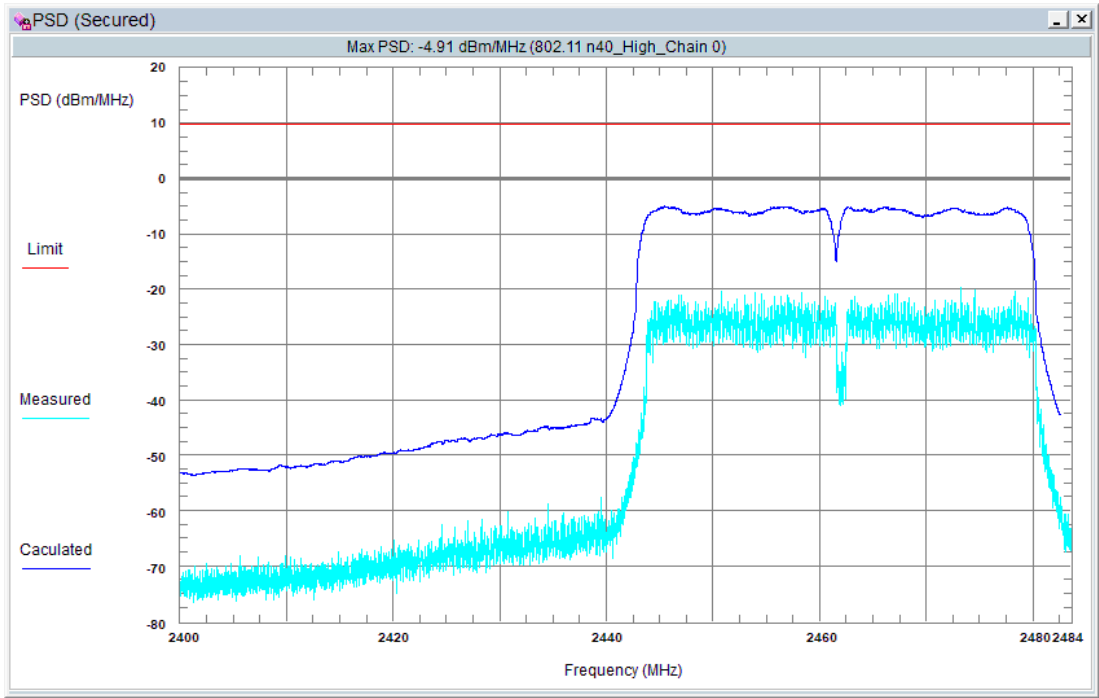

5 – ADAPTIVITY

Definition

Adaptive non-FHSS using LBT is a mechanism by which non-FHSS adaptive equipment avoids transmissions in a channel in the presence of an interfering signal in that channel. This mechanism shall operate as intended in the presence of an unwanted signal on frequencies other than those of the operating band.

Test Setup Block Diagram

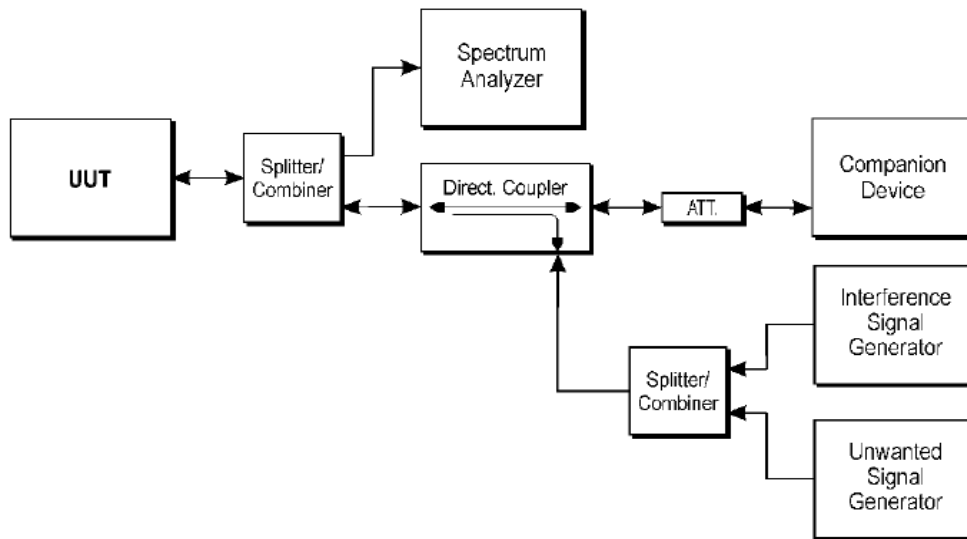

Test Procedure

The measurement procedure refer to ETSI EN 300 328 V2.2.2 (2019-07) §5.4.6

Test Data

Test Result: Compliant. Please refer to following tables.

Test Mode	Channel	Max.COT [ms]	Limit[ms]	Min.Idel Time[ms]	Limit[ms]	Verdict
802.11b	2412	1.568	≤ 13	0.060	≥ 0.018	PASS
	2472	5.236	≤ 13	0.443	≥ 0.018	PASS

Test Mode	Channel	Add Signal Type	Add Signal Time [ms]	Max. Short Time [%]	Limit [%]	Verdict
802.11b	2412	AWGN	2114	0	≤ 10	PASS
		CW	62152	0	≤ 10	PASS
	2472	AWGN	2114	0	≤ 10	PASS
		CW	62152	0	≤ 10	PASS

Please refer to following plots:

802.11b_Chain 0 2412(COT&Min Idel Period)

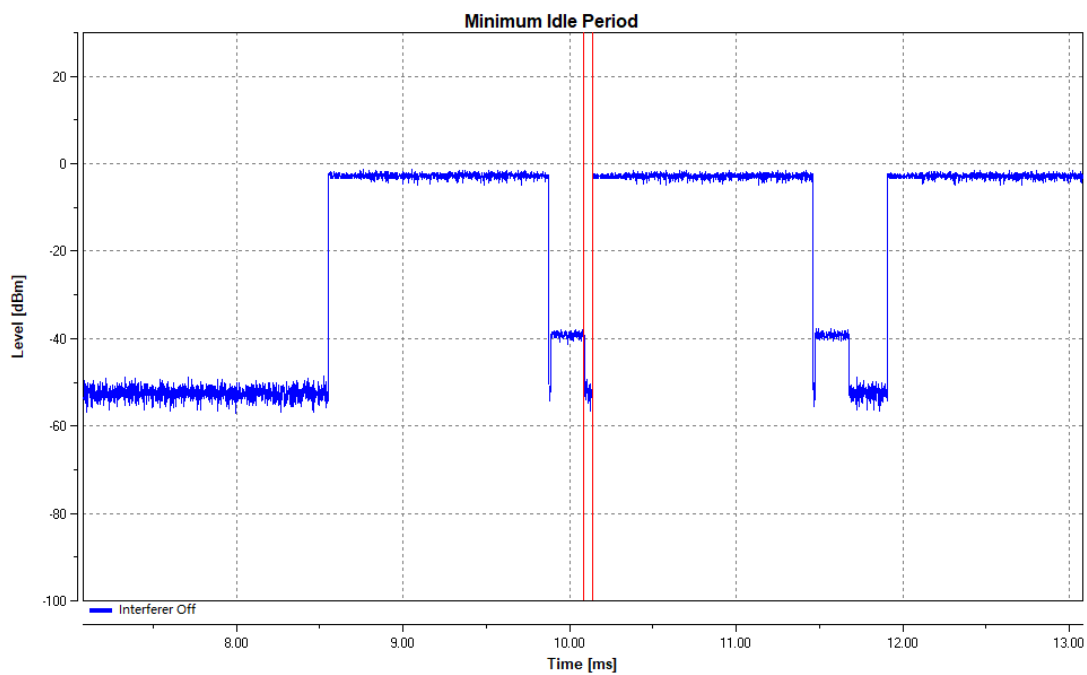
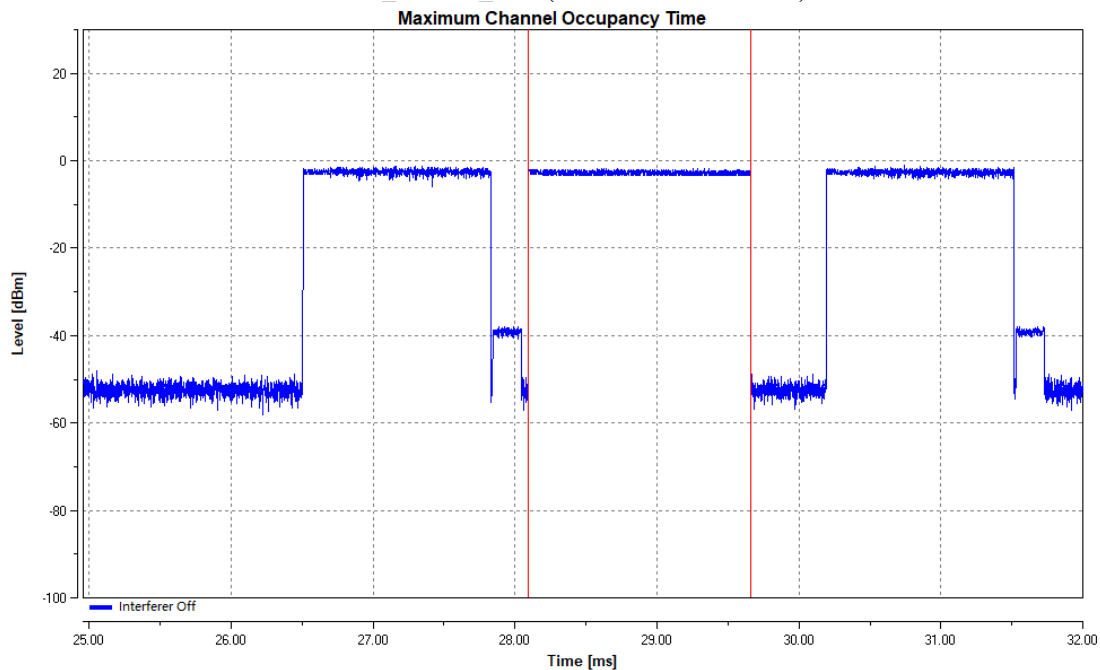

802.11b_Chain 0_2472(COT&Min Idle Period)

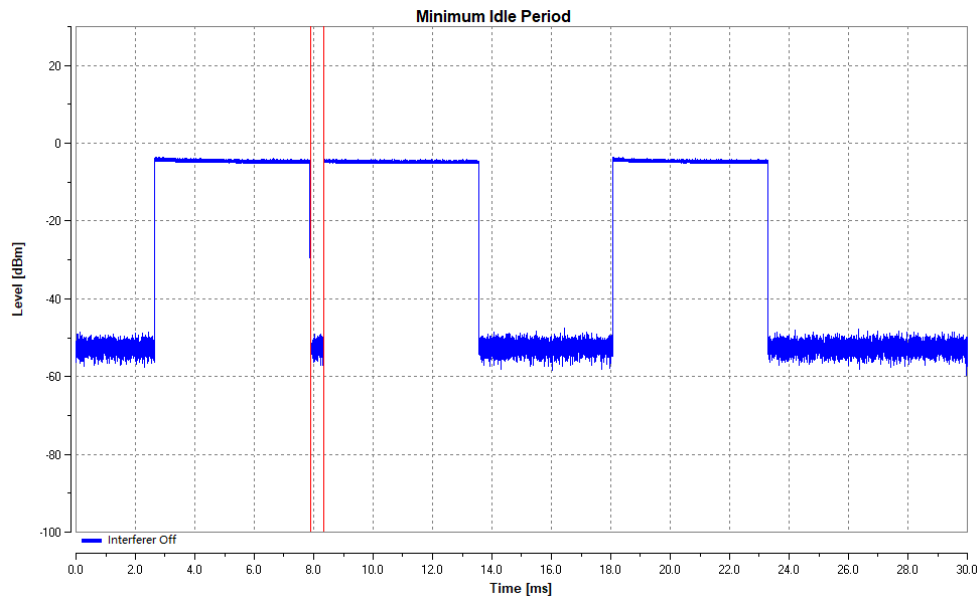
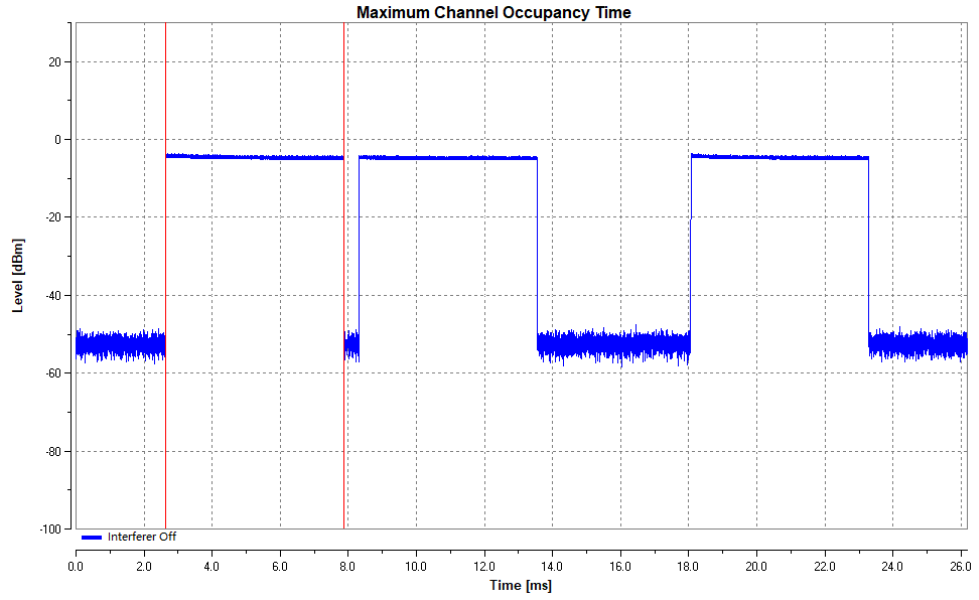

802.11b_Chain 0_2412(Adaptivity)

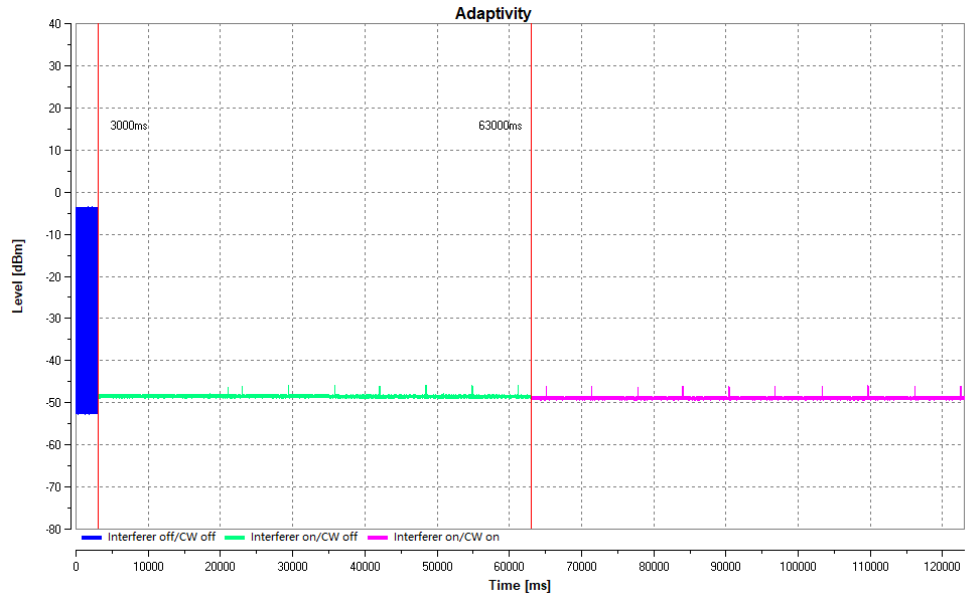

802.11b_Chain 0_2472(Adaptivity)

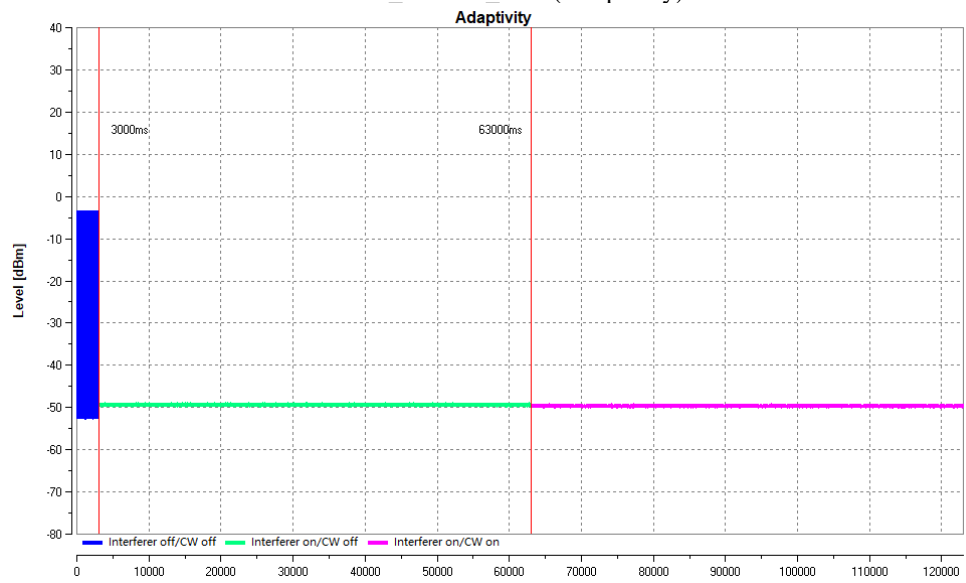

6 – OCCUPIED CHANNEL BANDWIDTH

Definition

The Occupied Channel Bandwidth is the bandwidth that contains 99 % of the power of the signal.

Limit

The Occupied Channel Bandwidth shall fall completely within the band given in clause 1. In addition, for non-adaptive equipment using wide band modulations other than FHSS and with e.i.r.p greater than 10 dBm, the occupied channel bandwidth shall be less than 20 MHz.

Test Procedure

The measurement procedure shall be as follows:

Step 1:

Connect the UUT to the spectrum analyser and use the following settings:

- Centre Frequency: The centre frequency of the channel under test
- Resolution BW: ~ 1 % of the span without going below 1 %
- Video BW: 3 × RBW
- Frequency Span for other types of equipment: 2 × Nominal Channel Bandwidth
- Detector Mode: RMS
- Trace Mode: Max Hold
- Sweep time: 1 s

Step 2:

Wait for the trace to stabilize.
Find the peak value of the trace and place the analyser marker on this peak.

Step 3:

Use the 99 % bandwidth function of the spectrum analyser to measure the Occupied Channel Bandwidth of the UUT. This value shall be recorded.

NOTE: Make sure that the power envelope is sufficiently above the noise floor of the analyser to avoid the noise signals left and right from the power envelope being taken into account by this measurement.

Test Data

Test Result: Compliant. Please refer to following tables.

Mode	Channel	Frequency (MHz)	Result (MHz)
802.11 b	Low	2412	16.687
	High	2472	16.527
802.11 g	Low	2412	17.166
	High	2472	17.166
802.11 n20	Low	2412	18.044
	High	2472	18.044
802.11 n40	Low	2422	36.248
	High	2462	36.248

Please refer to following plots:

802.11 b_Low Channel

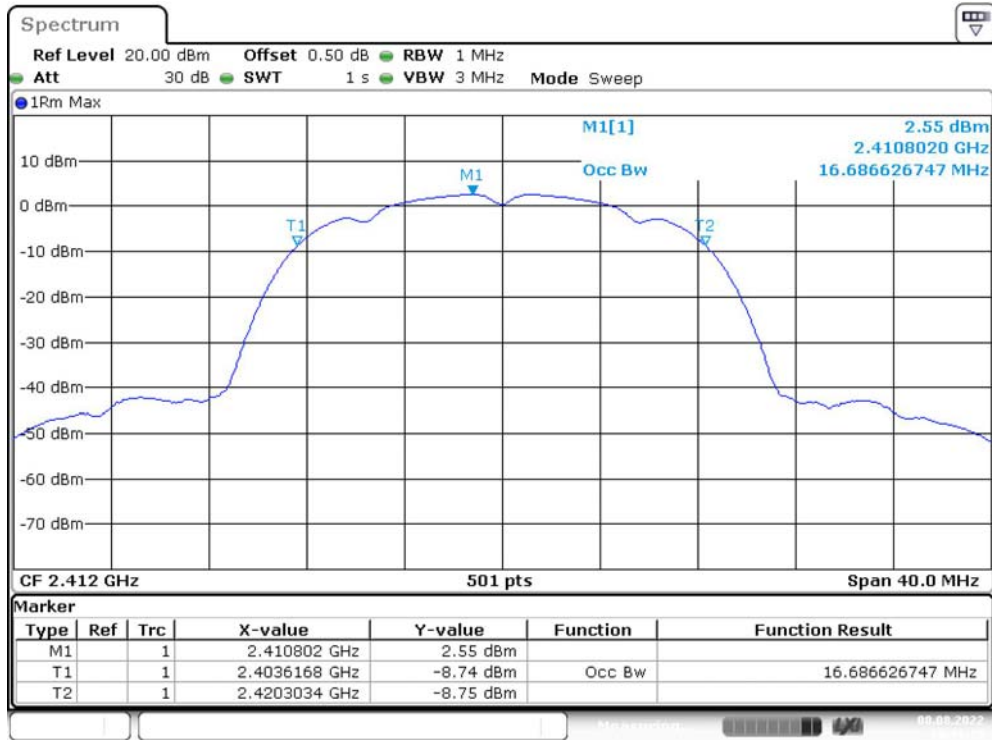

Date: 8.AUG.2022 14:48:13

802.11 b_High Channel

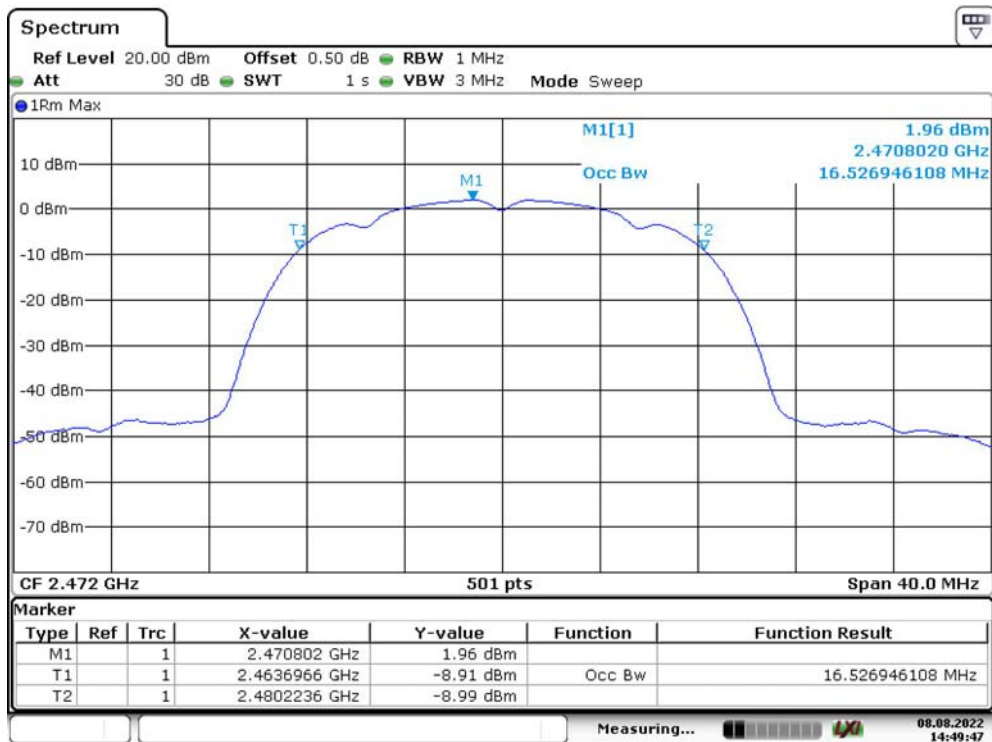

Date: 8.AUG.2022 14:49:47

802.11 g_Low Channel

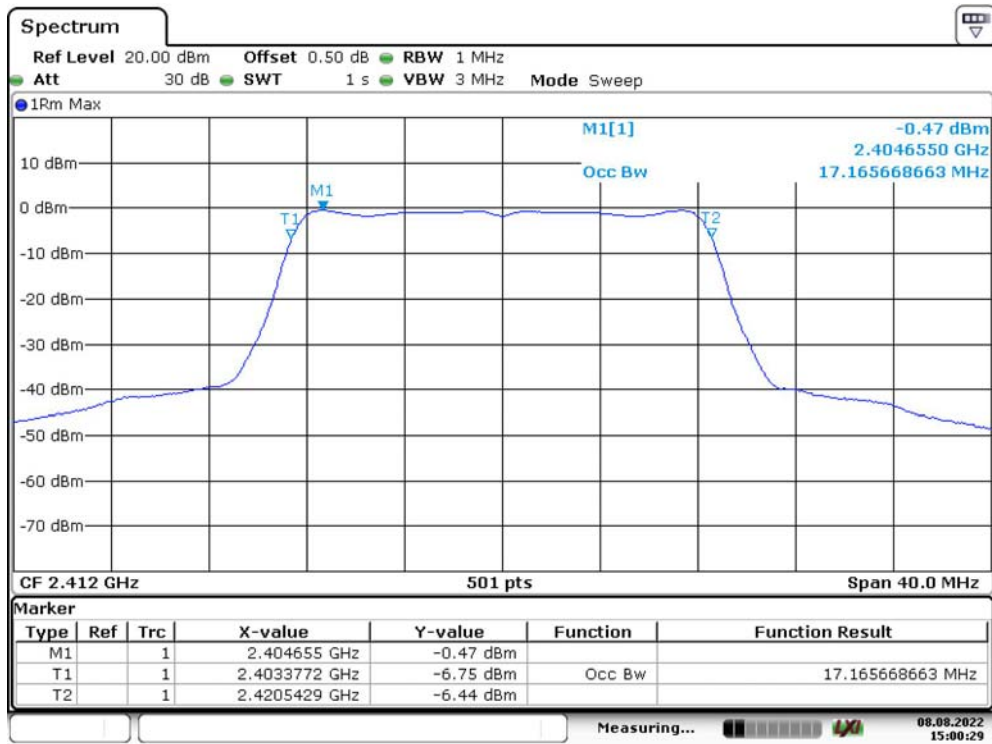

Date: 8.AUG.2022 15:00:30

802.11 g_High Channel

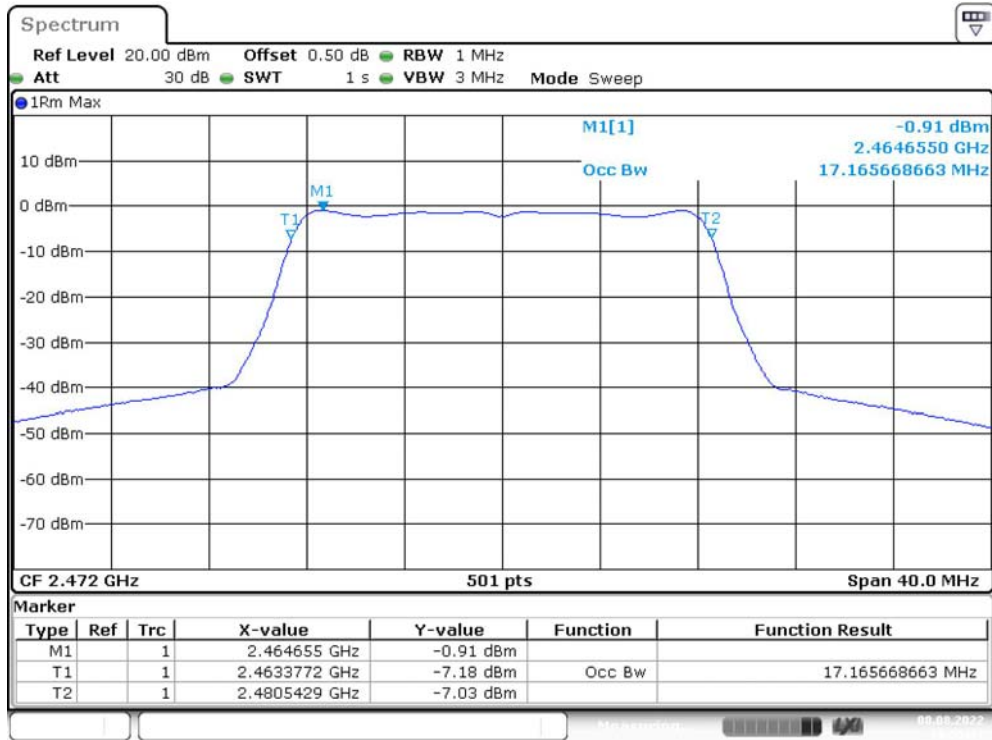

Date: 8.AUG.2022 14:56:42

802.11 n20 Low Channel

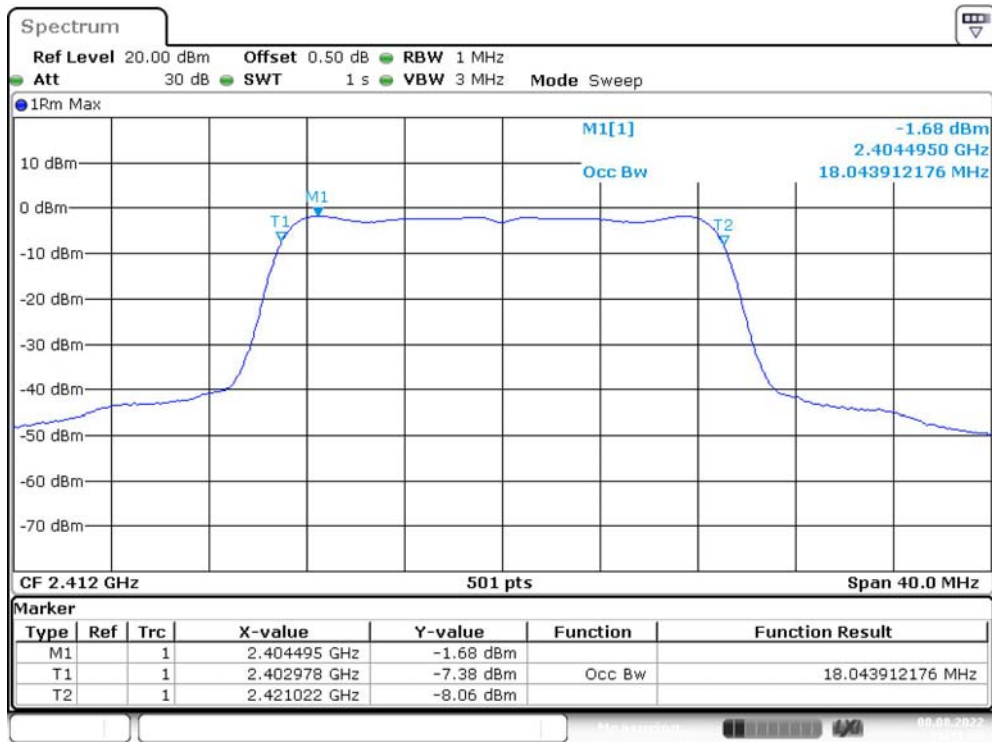

Date: 8.AUG.2022 15:11:37

802.11 n20 High Channel

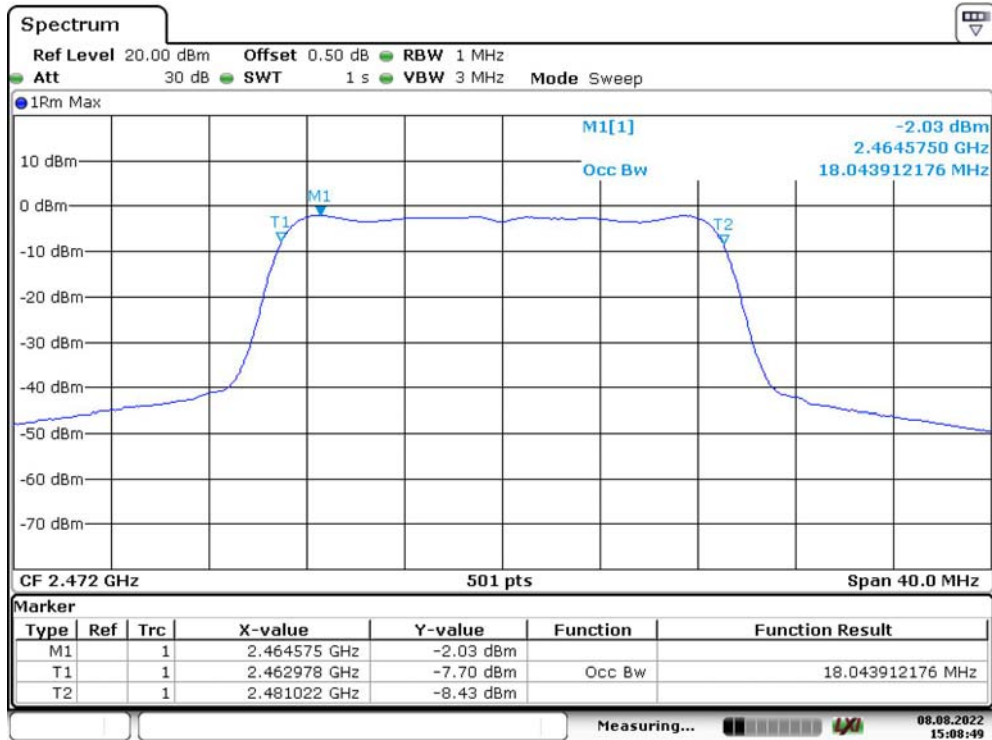

Date: 8.AUG.2022 15:08:49

802.11 n40 Low Channel

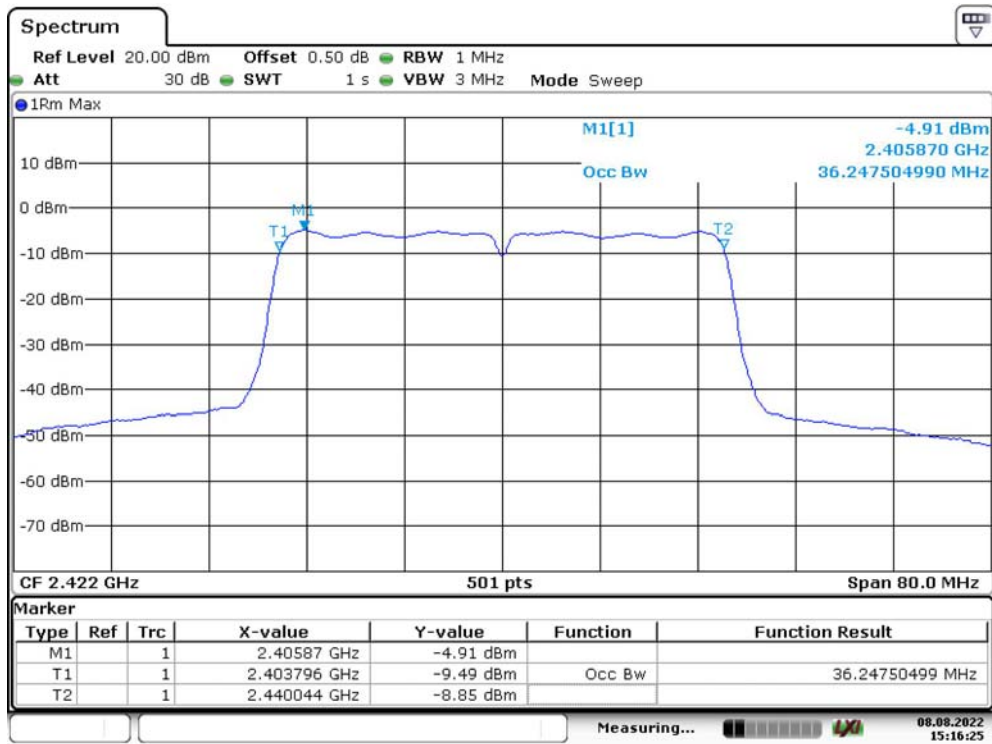

Date: 8.AUG.2022 15:16:25

802.11 n40 High Channel

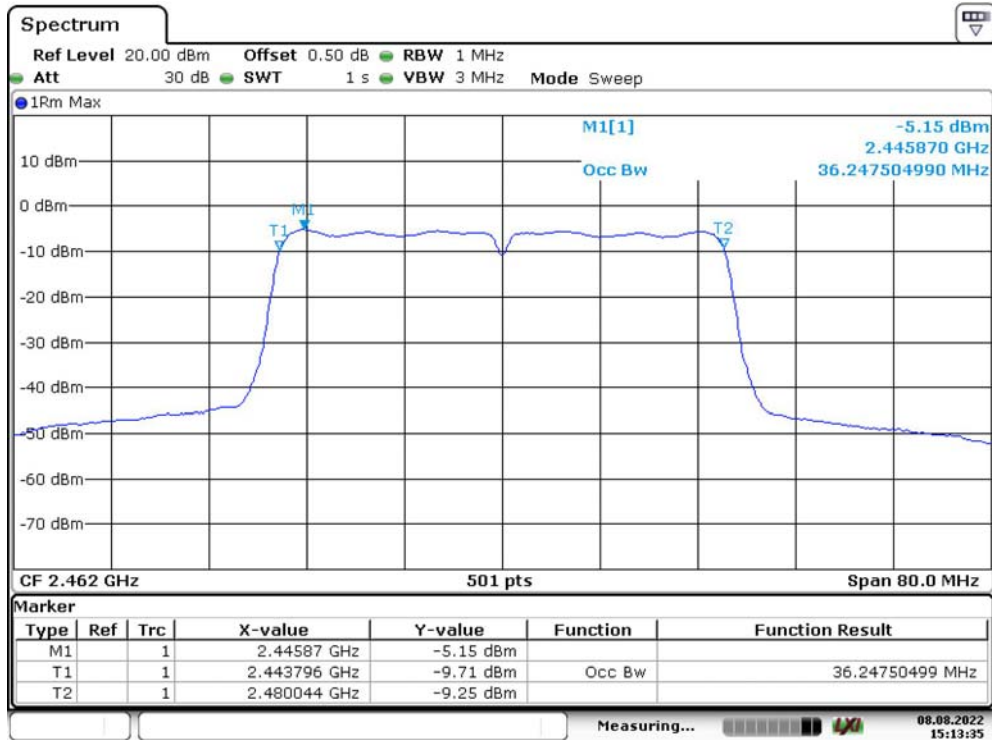

Date: 8.AUG.2022 15:13:35

7 – TRANSMITTER UNWANTED EMISSION IN THE OUT-OF-BAND DOMAIN

Definition

According to ETSI EN 300 328 V2.2.2 (2019-07) §4.3.2.8.2, Transmitter unwanted emissions in the out-of-band domain are emissions when the equipment is in Transmit mode, on frequencies immediately outside the allocated band , but excluding unwanted emissions in the spurious domain.

Limit

The transmitter unwanted emissions in the out-of-band domain shall not exceed the values provided by the mask in figure 3.

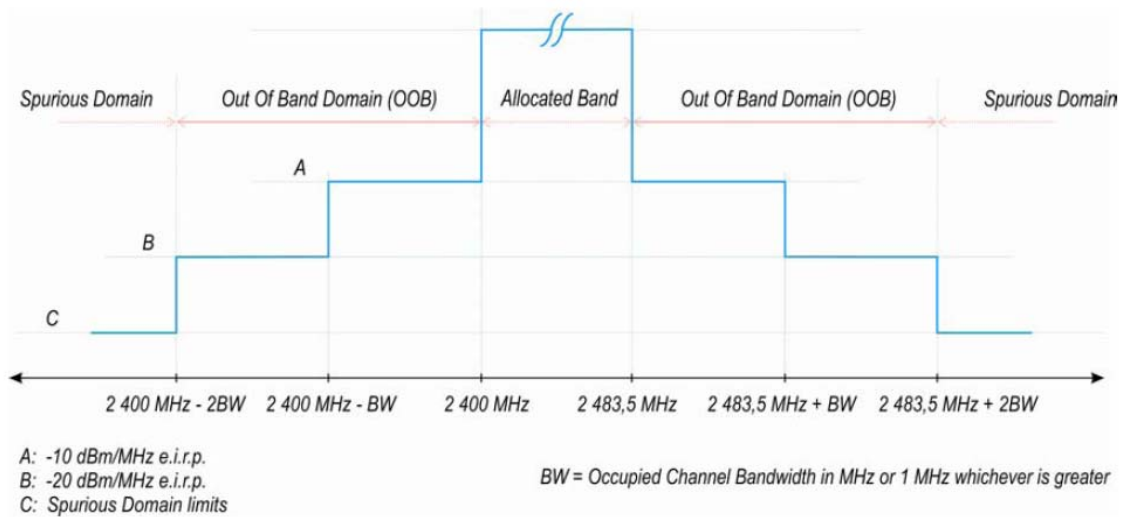

Figure 3: Transmit mask

Test Procedure

According to ETSI EN 300 328 V2.2.2 (2019-07) §5.4.8

Test Data

Test Result: Compliant. Please refer to following tables.

Mode	Channel	Frequency Segment	Reading (dBm/MHz)	Result (dBm/MHz)	Limit (dBm/MHz)
802.11 b	Low	2400MHz-2BW~2400-BW	-52.93	-49.04	≤ -20
		2400MHz-BW~2400MHz	-41.52	-37.63	≤ -10
	High	2483.5MHz~2483.5MHz+BW	-44.82	-40.93	≤ -10
		2483.5MHz+BW~2483.5MHz+2BW	-53.1	-49.21	≤ -20
802.11 g	Low	2400MHz-2BW~2400-BW	-51.73	-47.84	≤ -20
		2400MHz-BW~2400MHz	-37.7	-33.81	≤ -10
	High	2483.5MHz~2483.5MHz+BW	-37.42	-33.53	≤ -10
		2483.5MHz+BW~2483.5MHz+2BW	-52.58	-48.69	≤ -20
802.11 n20	Low	2400MHz-2BW~2400-BW	-53.26	-49.37	≤ -20
		2400MHz-BW~2400MHz	-39.27	-35.38	≤ -10
	High	2483.5MHz~2483.5MHz+BW	-35.58	-31.69	≤ -10
		2483.5MHz+BW~2483.5MHz+2BW	-50.51	-46.62	≤ -20
802.11 n40	Low	2400MHz-2BW~2400-BW	-54.98	-51.09	≤ -20
		2400MHz-BW~2400MHz	-41.33	-37.44	≤ -10
	High	2483.5MHz~2483.5MHz+BW	-43.25	-39.36	≤ -10
		2483.5MHz+BW~2483.5MHz+2BW	-55.51	-51.62	≤ -20

Note: The antenna Gain was added into the test result.

8 – TRANSMITTER UNWANTED EMISSION IN THE SPURIOUS DOMAIN

Definition

Transmitter unwanted emissions in the spurious domain are emissions outside the allocated band and outside the Out-of-band Domain as indicated in figure 3 when the equipment is in Transmit mode.

Limit

The transmitter unwanted emissions in the spurious domain shall not exceed the values given in the following table. In case of equipment with antenna connectors, these limits apply to emissions at the antenna port (conducted). For emissions radiated by the cabinet or emissions radiated by integral antenna equipment (without antenna connectors), these limits are e.r.p. for emissions up to 1 GHz and as e.i.r.p. for emissions above 1 GHz.

Transmitter limits for spurious emissions

Frequency range	Maximum power	Bandwidth
30 MHz to 47 MHz	-36 dBm	100 kHz
47 MHz to 74 MHz	-54 dBm	100 kHz
74 MHz to 87,5 MHz	-36 dBm	100 kHz
87,5 MHz to 118 MHz	-54 dBm	100 kHz
118 MHz to 174 MHz	-36 dBm	100 kHz
174 MHz to 230 MHz	-54 dBm	100 kHz
230 MHz to 470 MHz	-36 dBm	100 kHz
470 MHz to 694 MHz	-54 dBm	100 kHz
694 MHz to 1 GHz	-36 dBm	100 kHz
1 GHz to 12,75 GHz	-30 dBm	1 MHz

Test Procedure

According to ETSI EN 300 328 V2.2.2 (2019-07) §5.4.9

Test Data

Test Result: Compliant. Pre-scan all modes, worst case please refer to following tables.

Radiated:

802.11 b low channel

2412 MHz

Frequency (MHz)	Polar (H/V)	Receiver Reading (dBµV)	Substituted Method			Absolute Level (dBm)	Limit (dBm)	Margin (dB)
			Substituted Level (dBm)	Antenna Gain (dBd/dBi)	Cable Loss (dB)			
4824.00	H	50.36	-59.41	14.20	1.55	-46.76	-30.00	16.76
4824.00	V	50.35	-59.28	14.20	1.55	-46.63	-30.00	16.63
7236.00	H	50.89	-52.04	13.01	1.59	-40.62	-30.00	10.62
7236.00	V	50.49	-52.58	13.01	1.59	-41.16	-30.00	11.16
221.60	H	56.23	-59.24	0.00	0.50	-59.74	-54.00	5.74
223.00	V	61.01	-57.04	0.00	0.50	-57.54	-54.00	3.54

802.11 b high channel

2472 MHz

Frequency (MHz)	Polar (H/V)	Receiver Reading (dBµV)	Substituted Method			Absolute Level (dBm)	Limit (dBm)	Margin (dB)
			Substituted Level (dBm)	Antenna Gain (dBd/dBi)	Cable Loss (dB)			
4944.00	H	50.27	-59.31	13.94	1.45	-46.82	-30.00	16.82
4944.00	V	51.26	-57.65	13.94	1.45	-45.16	-30.00	15.16
7416.00	H	50.24	-52.05	13.28	1.41	-40.18	-30.00	10.18
7416.00	V	50.36	-52.31	13.28	1.41	-40.44	-30.00	10.44
221.65	H	57.14	-58.33	0.00	0.50	-58.83	-54.00	4.83
223.63	V	61.55	-56.53	0.00	0.50	-57.03	-54.00	3.03

Note 1: The unit of antenna gain is dBd for frequency below 1GHz and is dBi for frequency above 1GHz.

Note 2:

Absolute Level = Substituted Level - Cable loss + Antenna Gain

Margin = Limit- Absolute Level

Conducted:

802.11 b_Low Channel

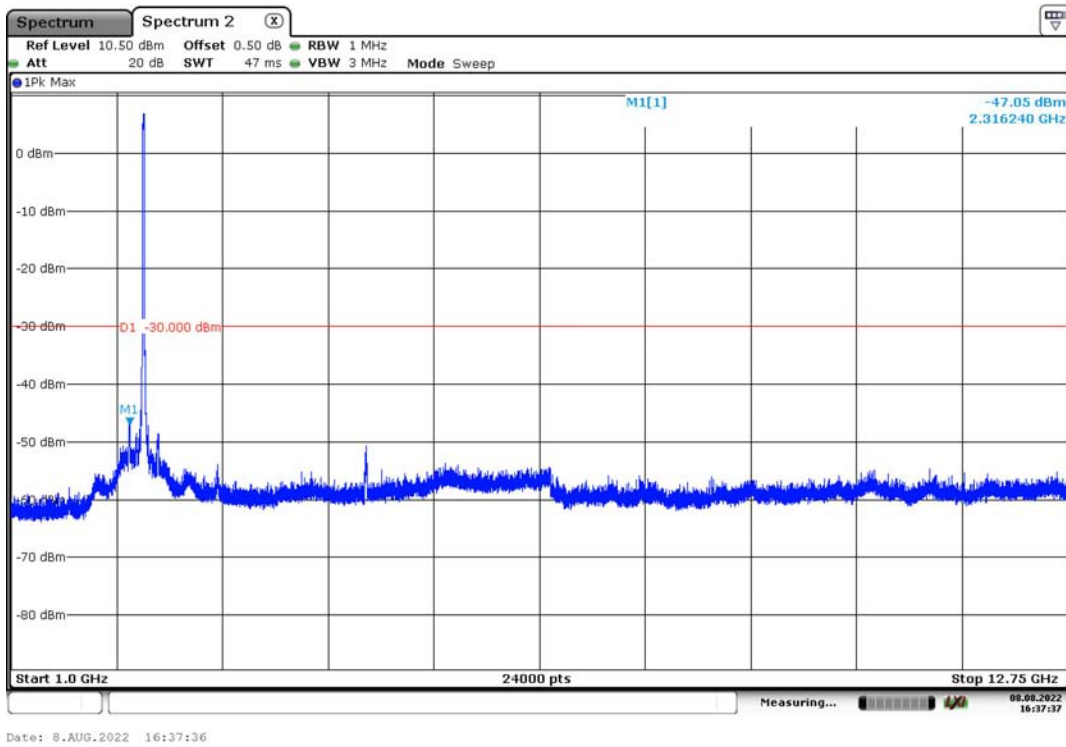
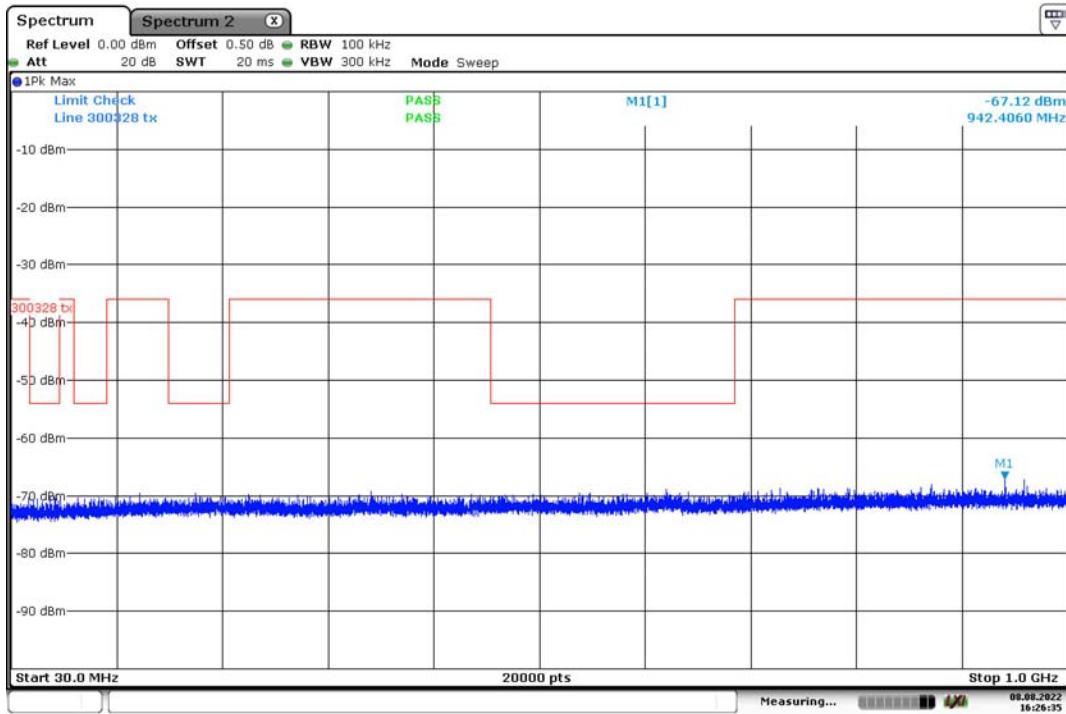

802.11 b_High Channel

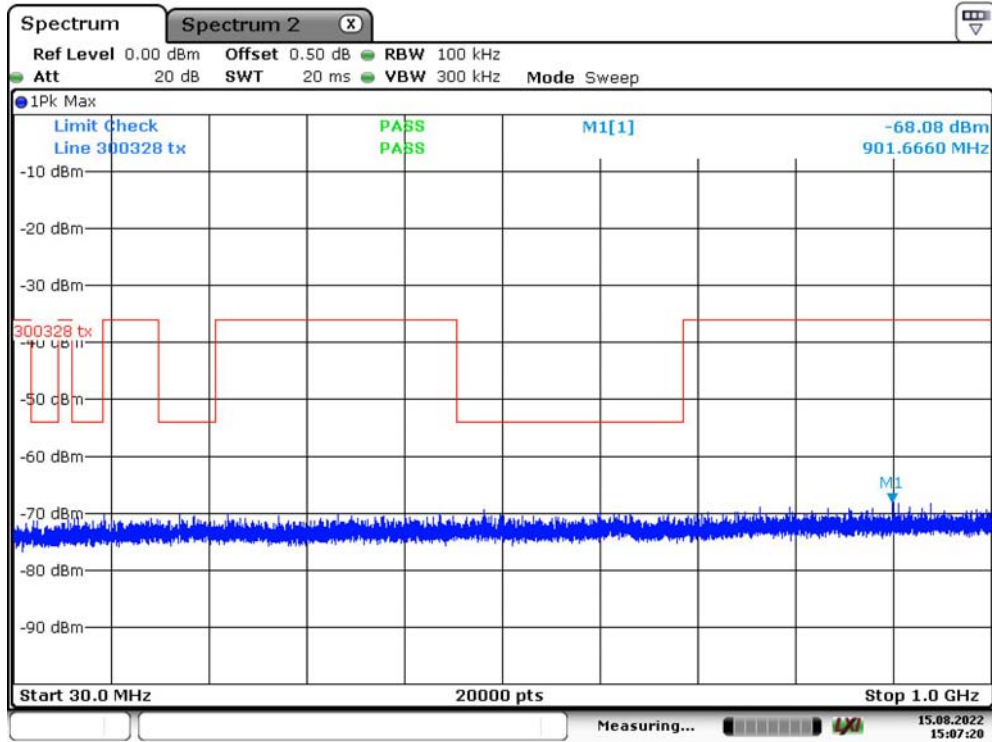

Date: 15.AUG.2022 15:07:20

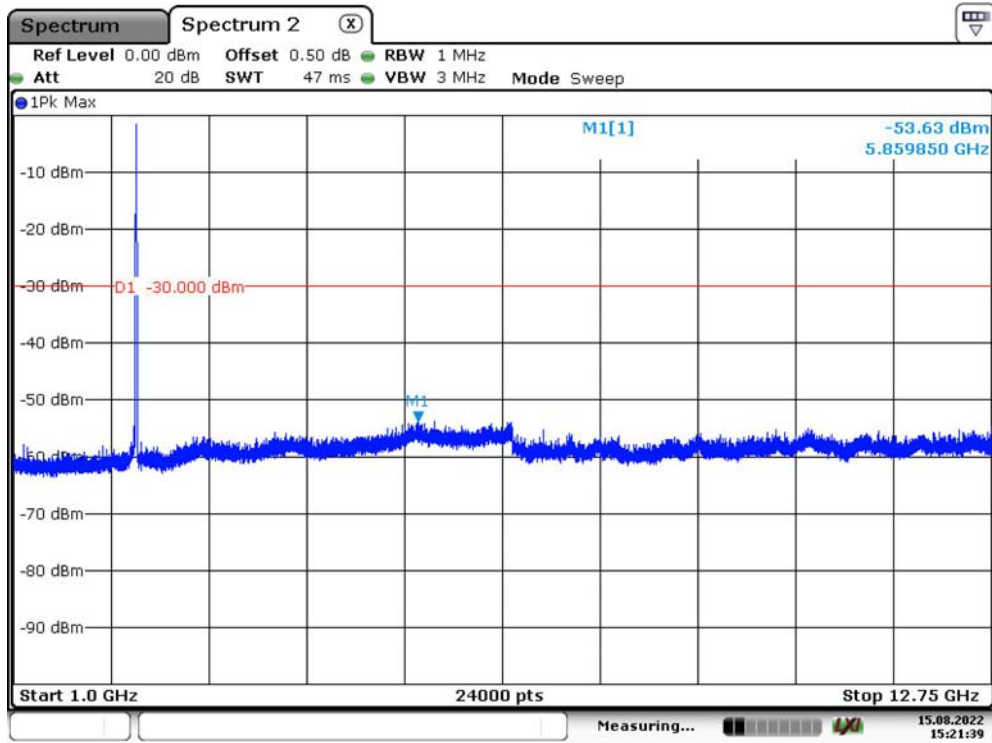

Date: 15.AUG.2022 15:21:39

802.11 g_Low Channel

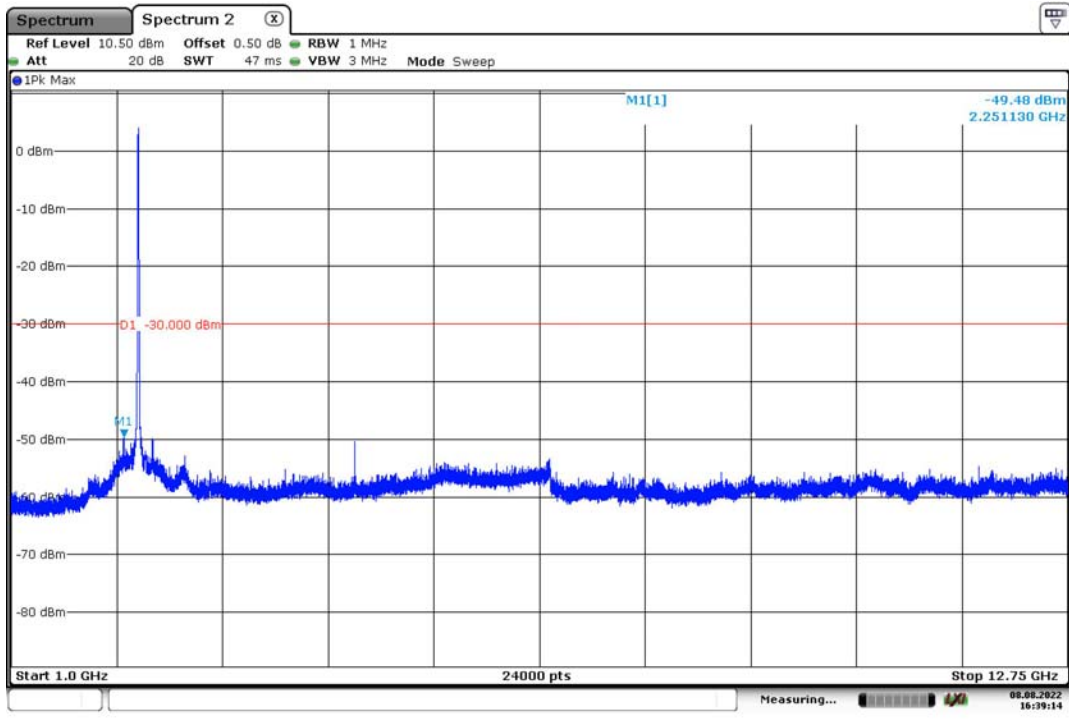
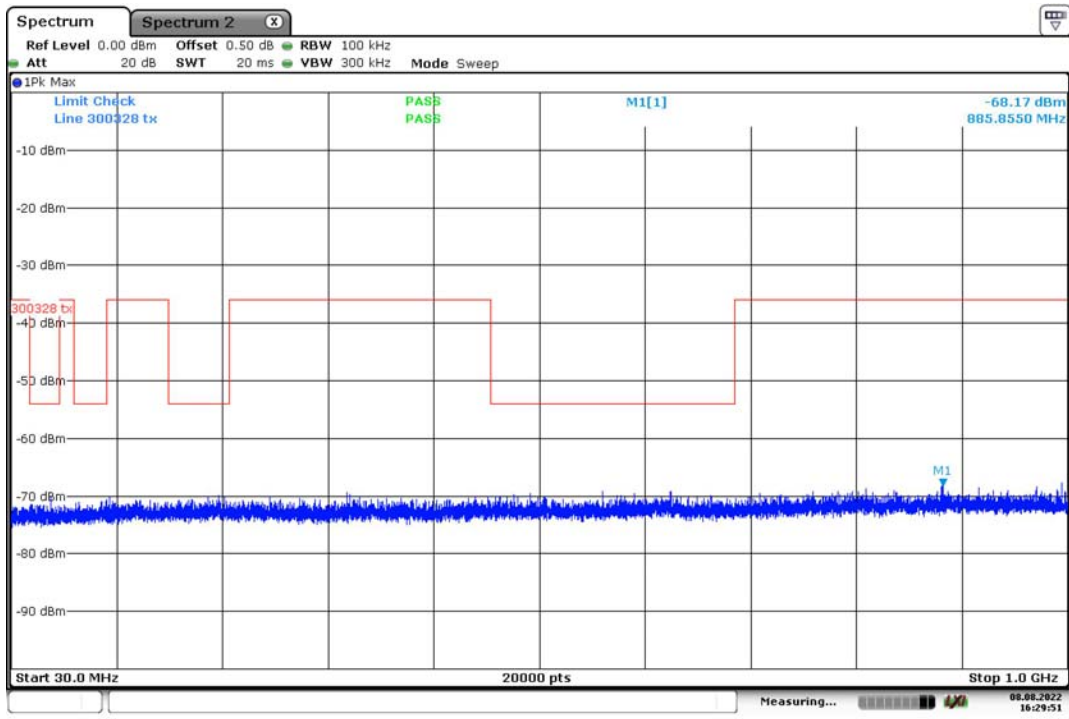

802.11 g_High Channel

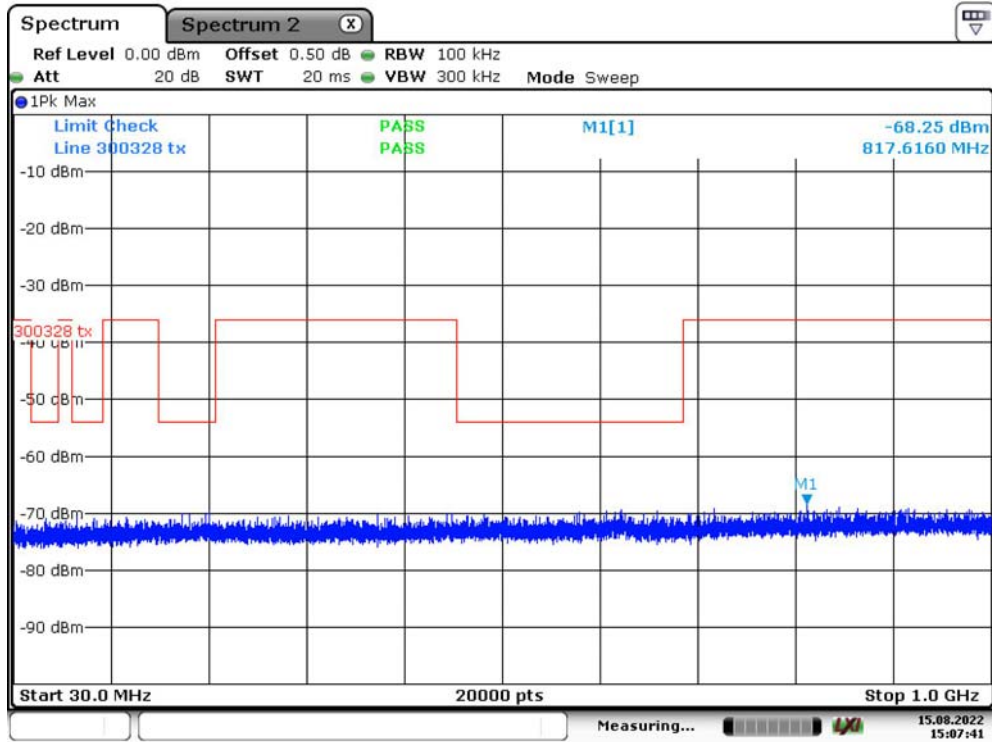

Date: 15.AUG.2022 15:07:40

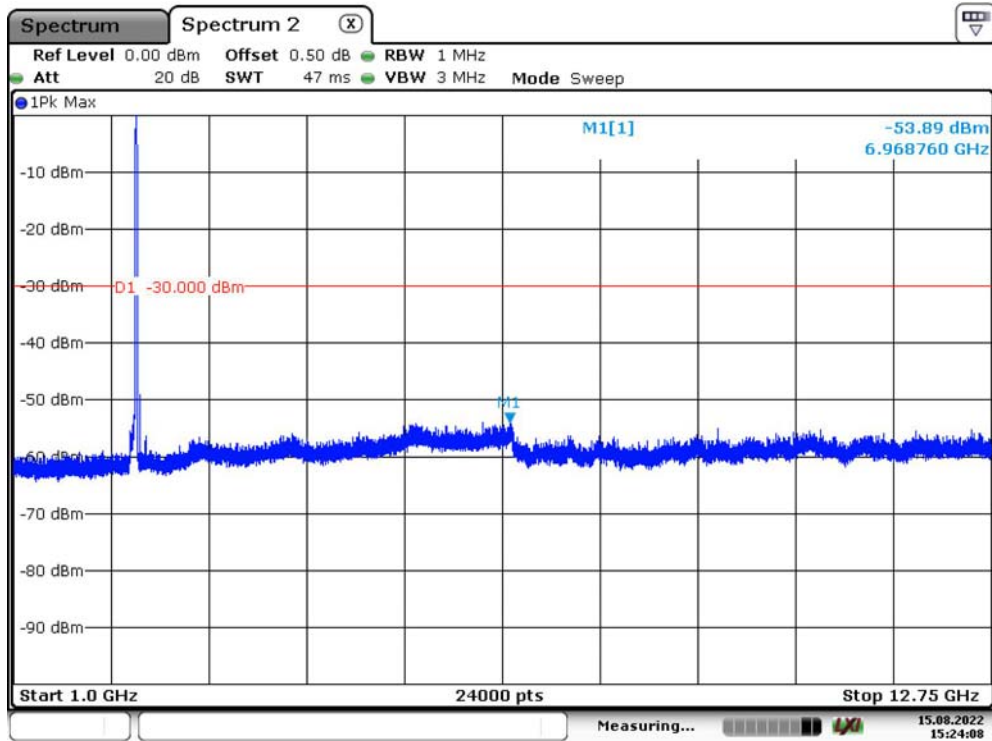

Date: 15.AUG.2022 15:24:07

802.11 n20_Low Channel

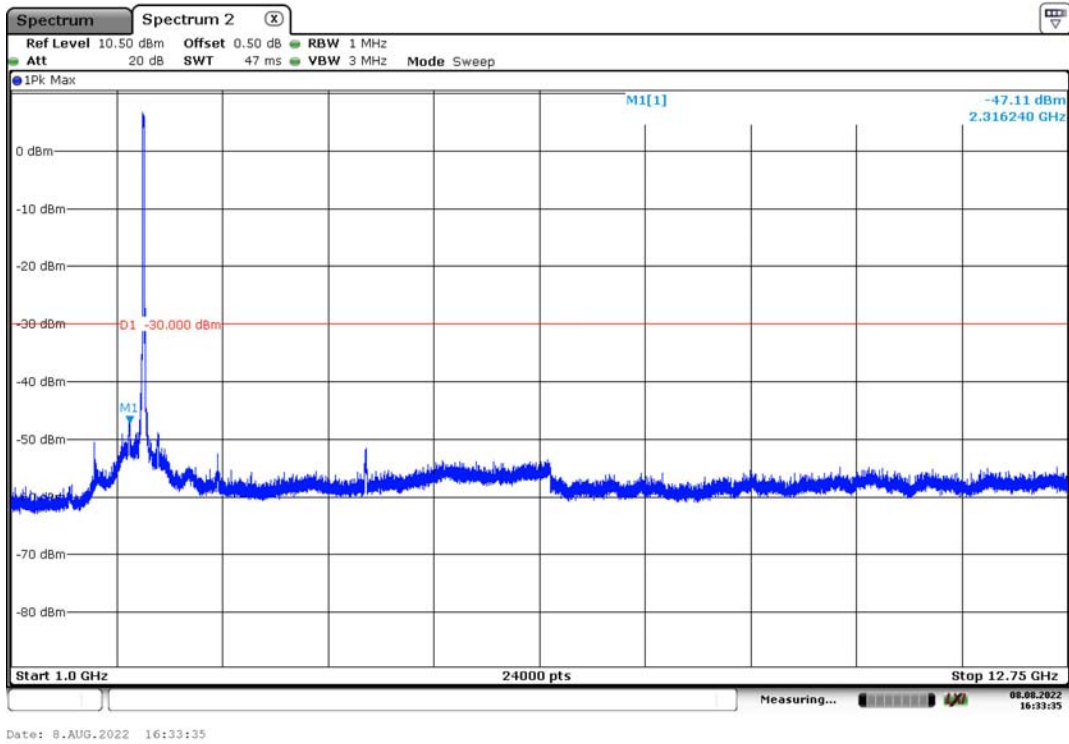
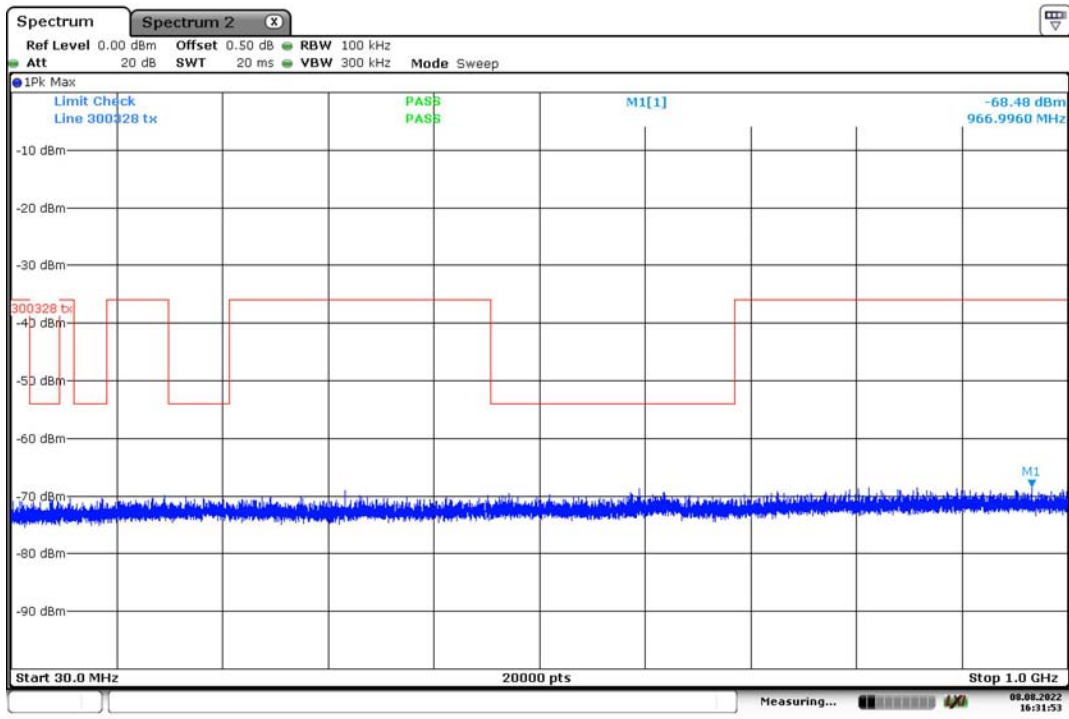

802.11 n20_High Channel

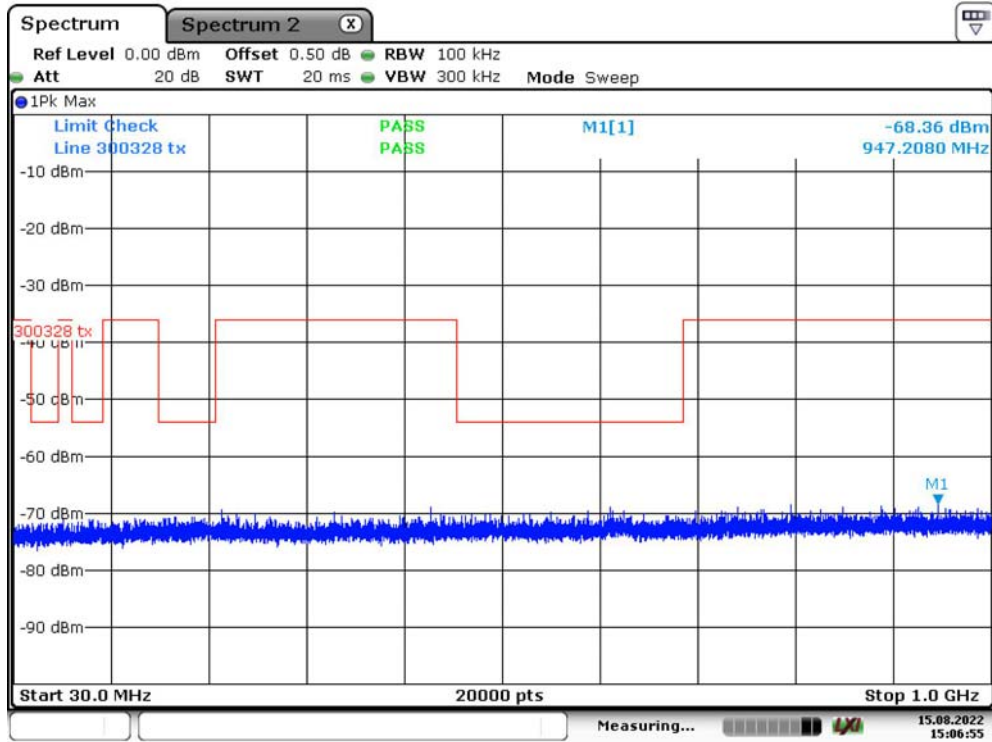

Date: 15.AUG.2022 15:06:55

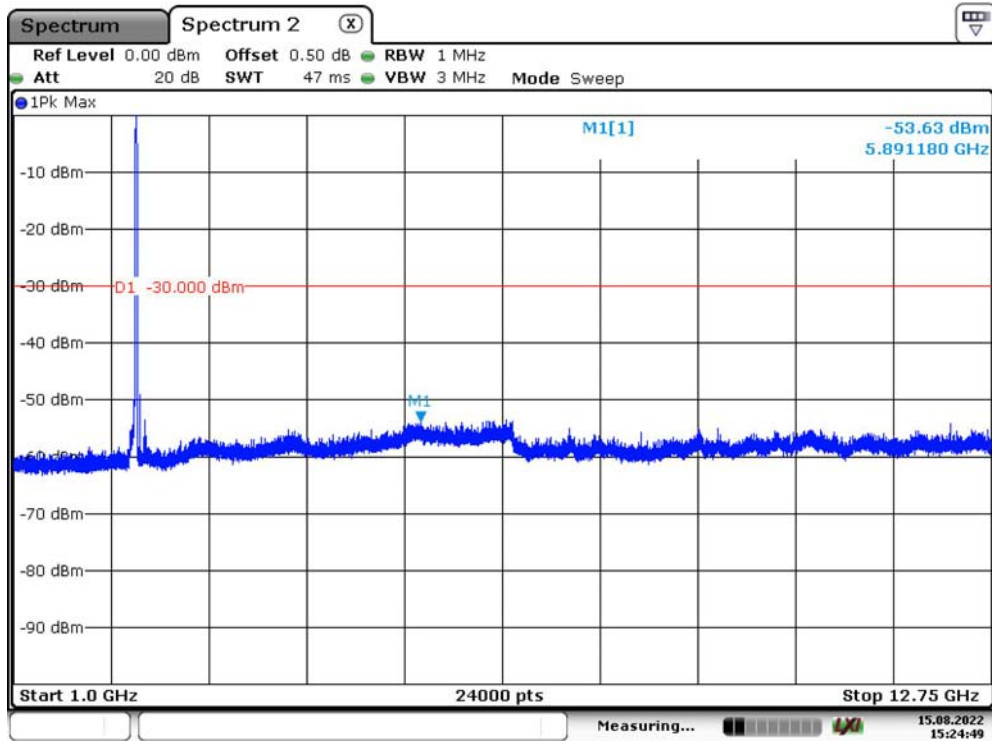

Date: 15.AUG.2022 15:24:49

802.11 n40_Low Channel

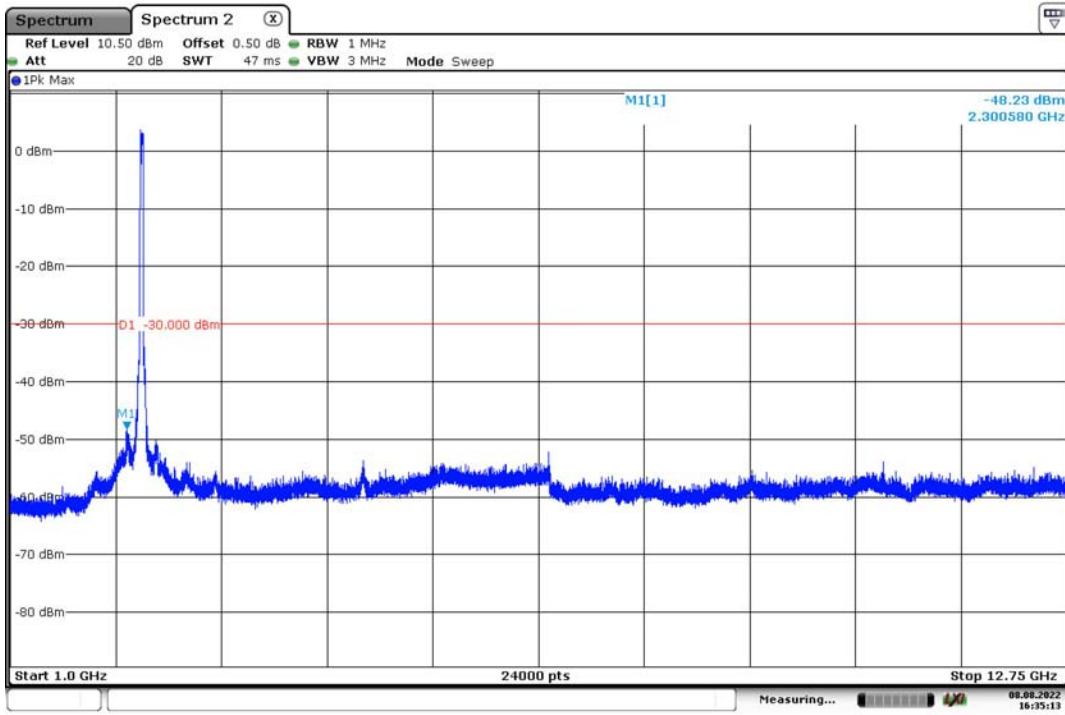
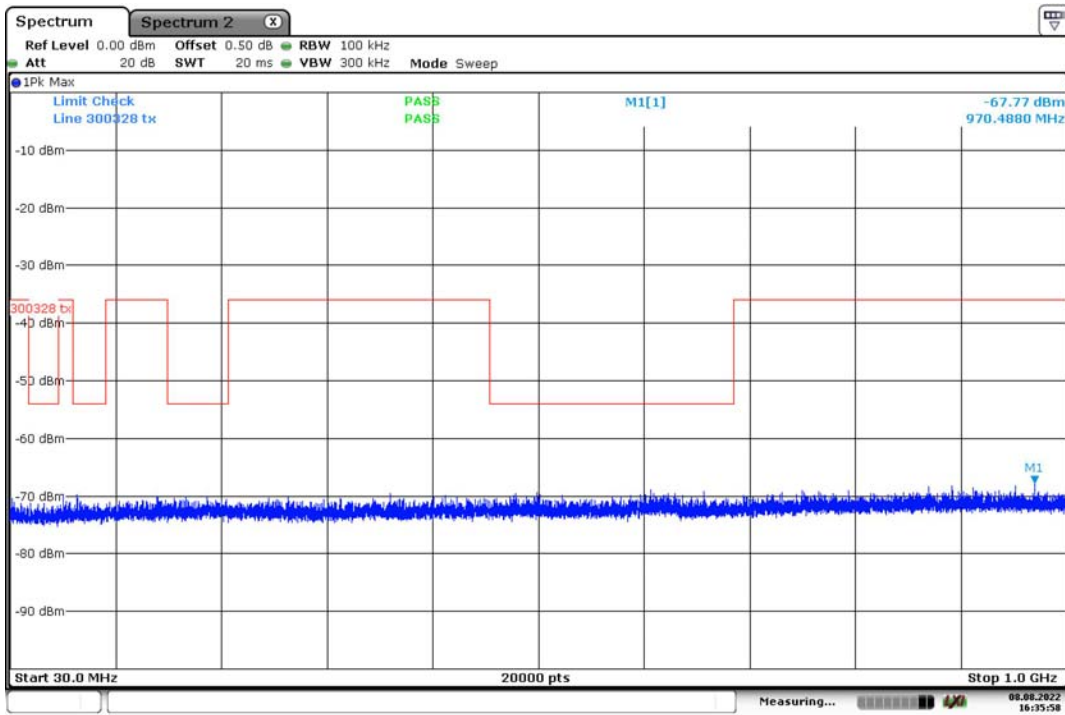

802.11 n40_High Channel

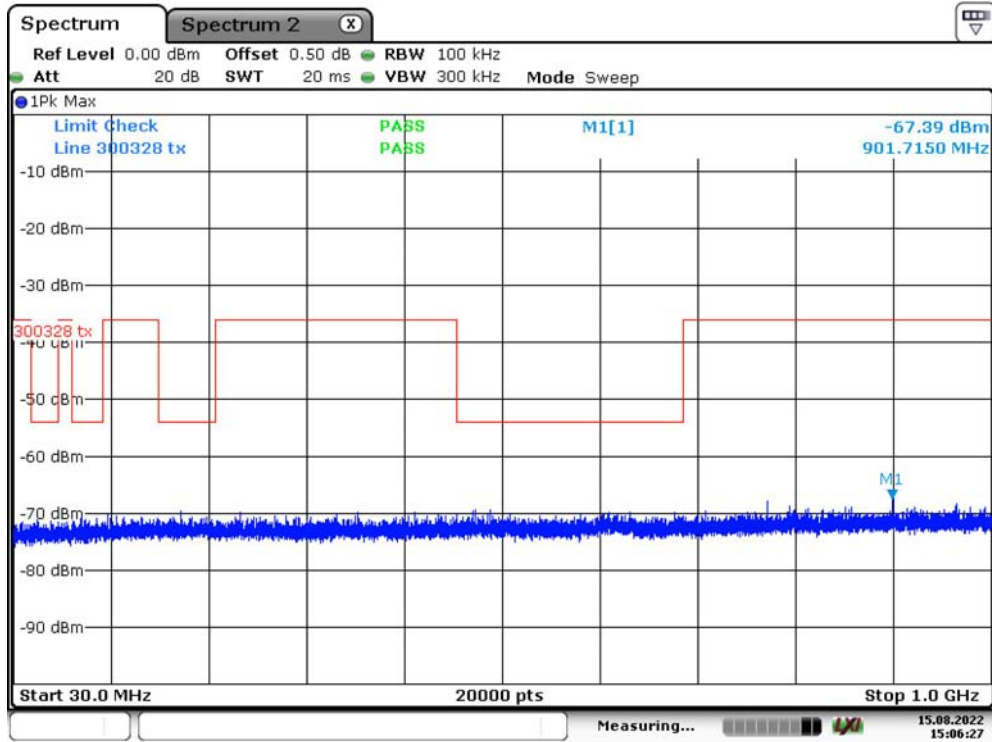

Date: 15.AUG.2022 15:06:28

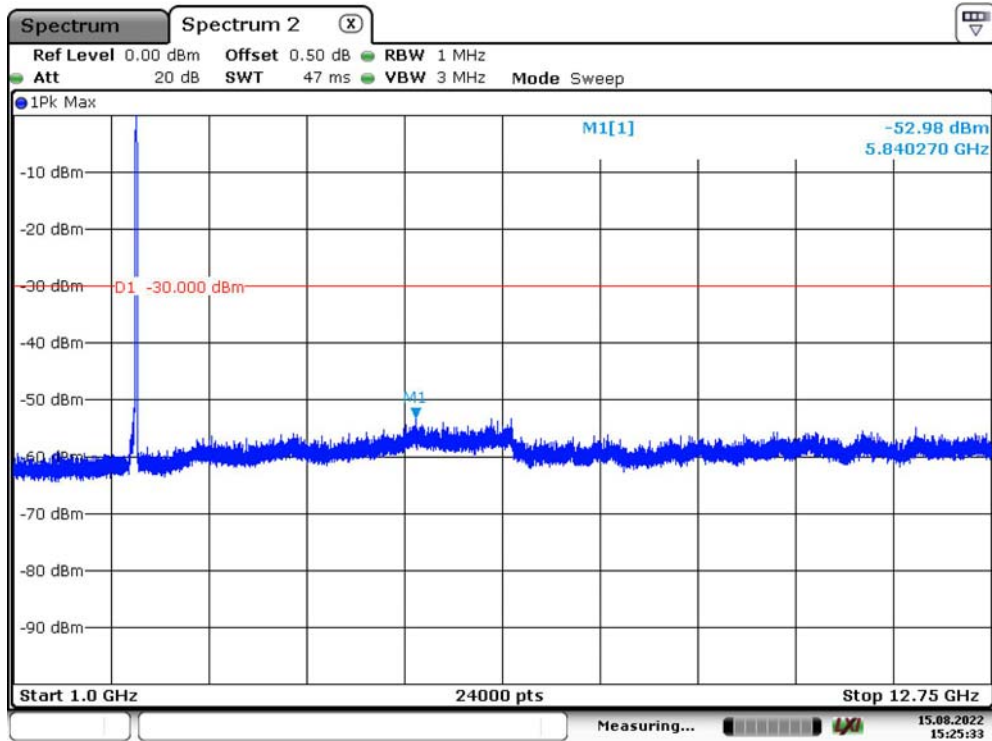

Date: 15.AUG.2022 15:25:33

9 – RECEIVER SPURIOUS EMISSIONS

Definition

Receiver spurious emissions are emissions at any frequency when the equipment is in receive mode.

Limit

The receiver spurious emissions shall not exceed the values given in the following table.

In case of equipment with antenna connectors, these limits apply to emissions at the antenna port (conducted). For emissions radiated by the cabinet or emissions radiated by integral antenna equipment (without antenna connectors), these limits are e.r.p. for emissions up to 1 GHz and e.i.r.p. for emissions above 1 GHz.

Spurious emission limits for receivers

Frequency range	Maximum power	Bandwidth
30 MHz to 1 GHz	-57 dBm	100 kHz
1 GHz to 12,75 GHz	-47 dBm	1 MHz

Test Procedure

According to ETSI EN 300 328 V2.2.2 (2019-07) §5.4.10

Test Data

Test Result: Compliant. Pre-scan all modes, worst case please refer to following tables.

802.11 b Low channel 2412 MHz

Frequency (MHz)	Polar (H/V)	Receiver Reading (dBμV)	Substituted Method			Absolute Level (dBm)	Limit (dBm)	Margin (dB)
			Substituted Level (dBm)	Antenna Gain (dBd/dBi)	Cable Loss (dB)			
1589.50	H	50.64	-68.27	10.04	0.75	-58.98	-47.00	11.98
1265.35	V	50.87	-67.33	7.95	1.16	-60.54	-47.00	13.54
213.18	H	55.25	-60.09	0.00	0.49	-60.58	-57.00	3.58
223.00	V	57.91	-60.14	0.00	0.50	-60.64	-57.00	3.64

802.11 b High channel 2472 MHz

Frequency (MHz)	Polar (H/V)	Receiver Reading (dBμV)	Substituted Method			Absolute Level (dBm)	Limit (dBm)	Margin (dB)
			Substituted Level (dBm)	Antenna Gain (dBd/dBi)	Cable Loss (dB)			
1879.54	H	50.57	-66.20	11.66	0.95	-55.49	-47.00	8.49
1649.35	V	50.66	-68.04	10.45	0.71	-58.30	-47.00	11.30
213.23	H	55.45	-59.89	0.00	0.49	-60.38	-57.00	3.38
223.00	V	58.54	-59.51	0.00	0.50	-60.01	-57.00	3.01

Note 1: The unit of antenna gain is dBd for frequency below 1GHz and is dBi for frequency above 1GHz.

Note 2:

Absolute Level = Substituted Level - Cable loss + Antenna Gain

Margin = Limit- Absolute Level

Conducted:

802.11 b_Low Channel

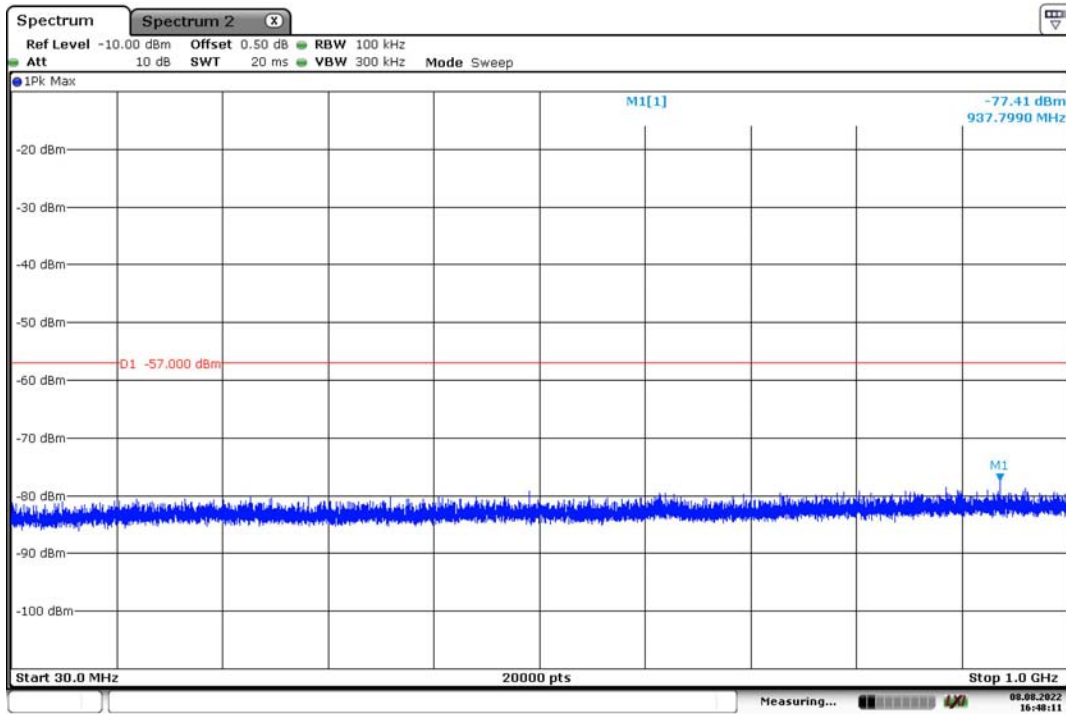

Date: 8.AUG.2022 16:48:11

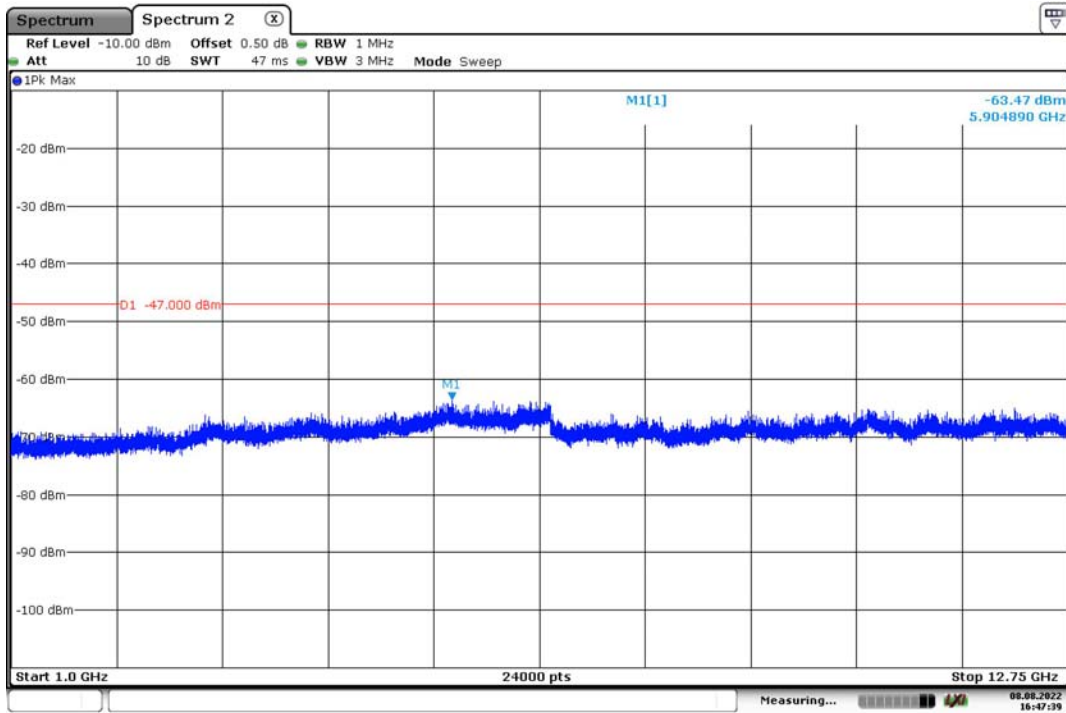

Date: 8.AUG.2022 16:47:39

802.11 b_High Channel

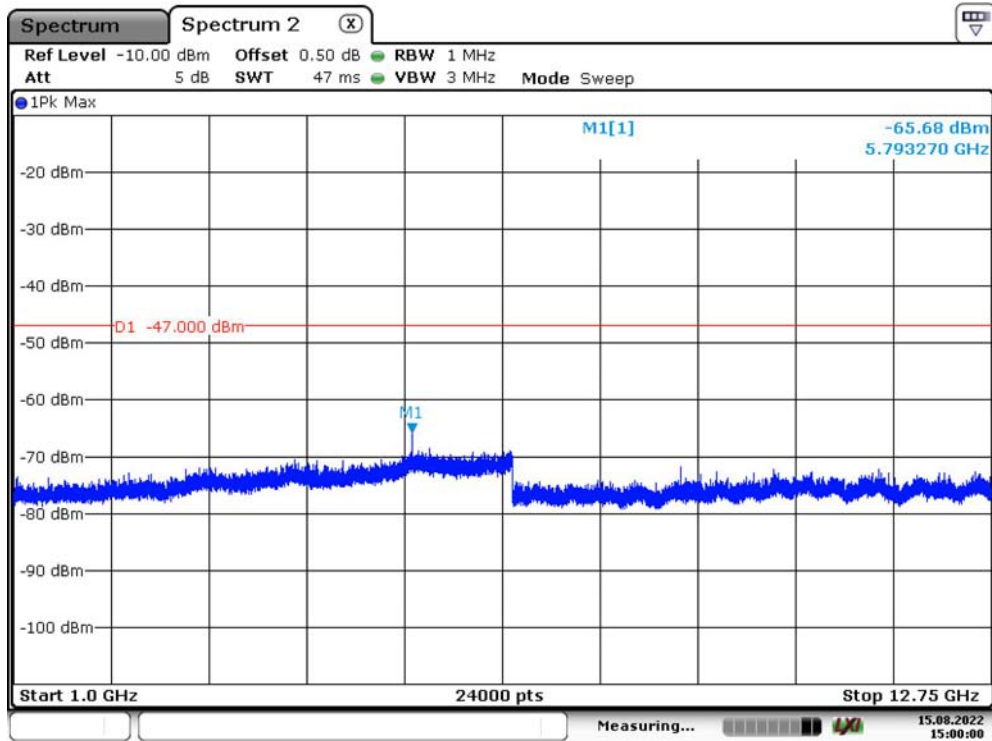
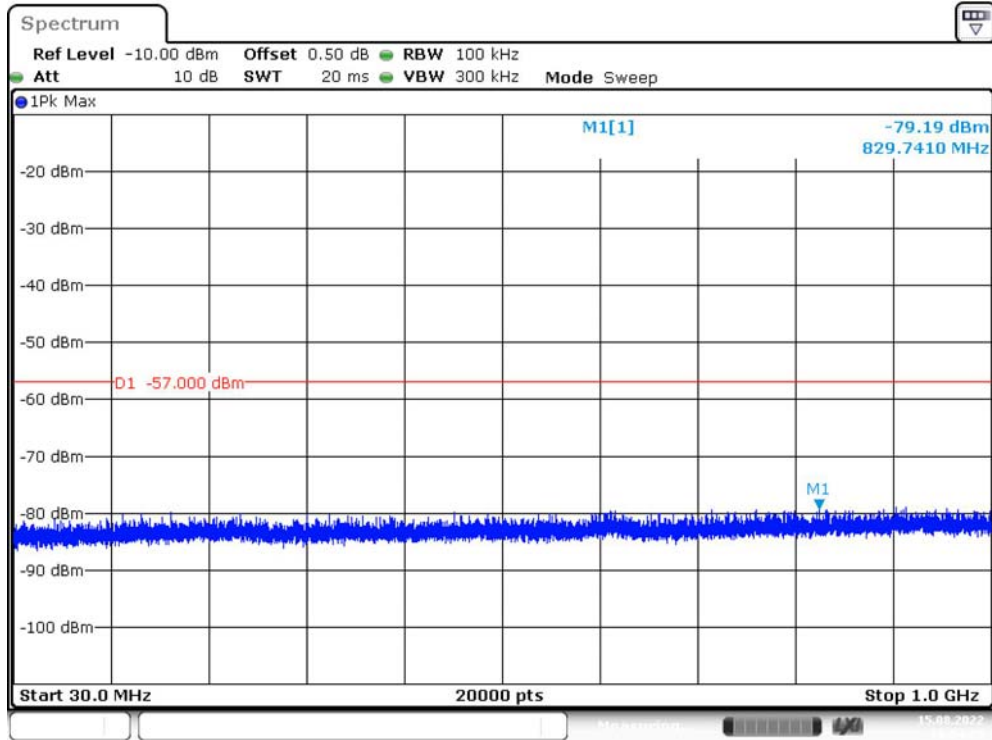

802.11 g_Low Channel

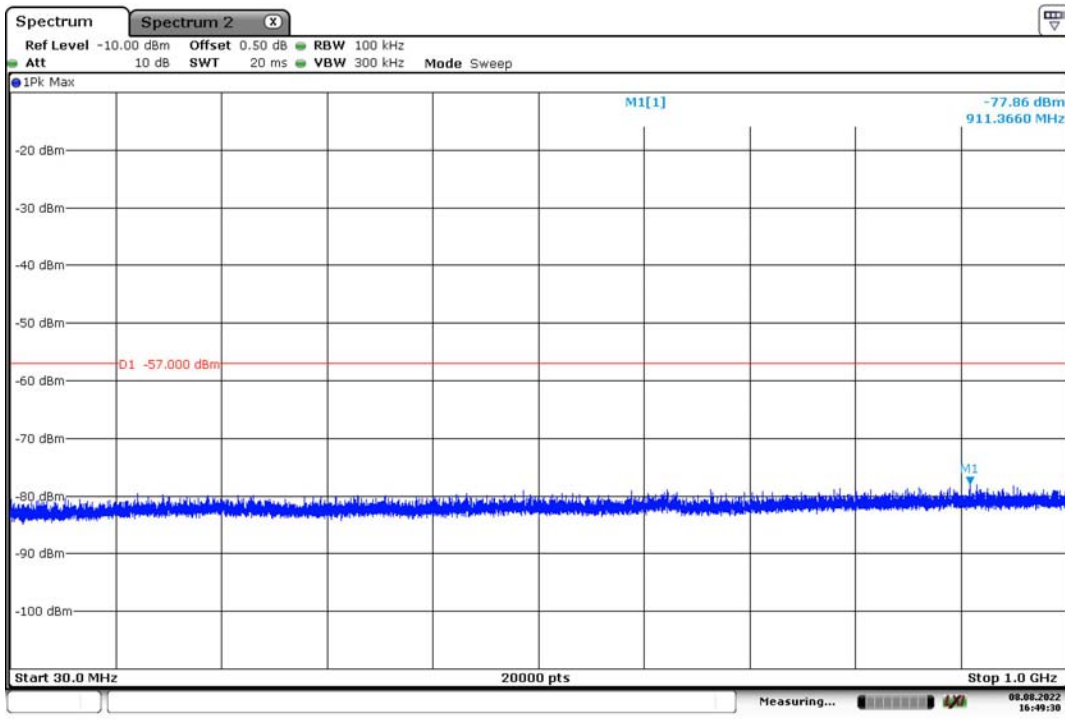

Date: 8.AUG.2022 16:49:31

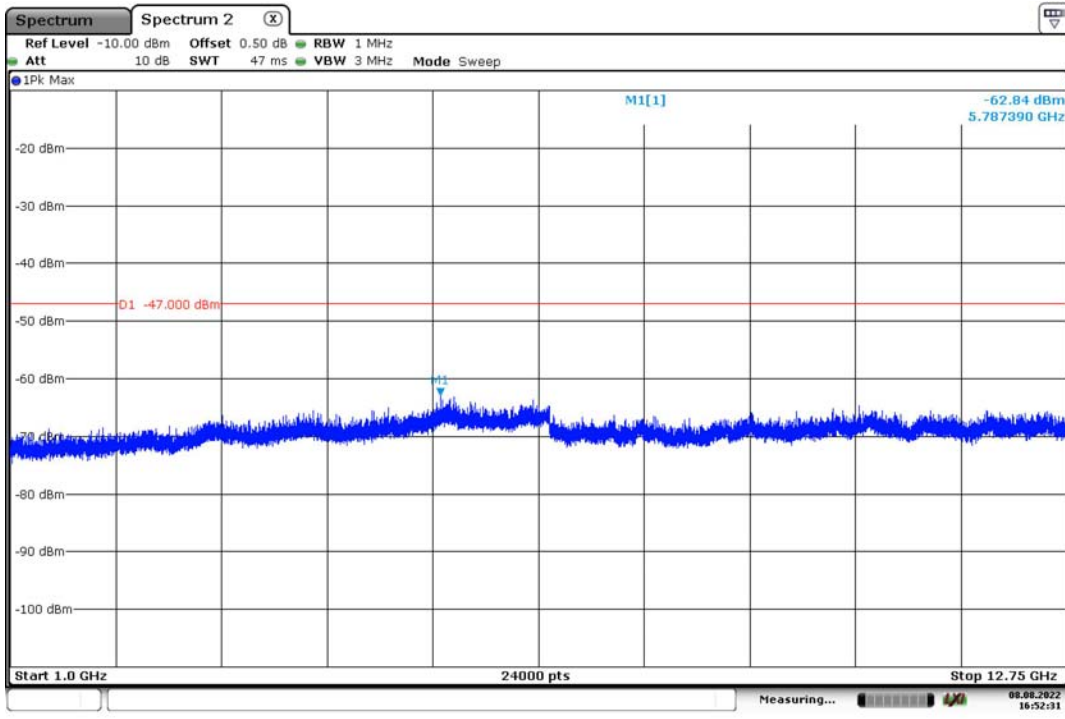

Date: 8.AUG.2022 16:52:32

802.11 g_High Channel

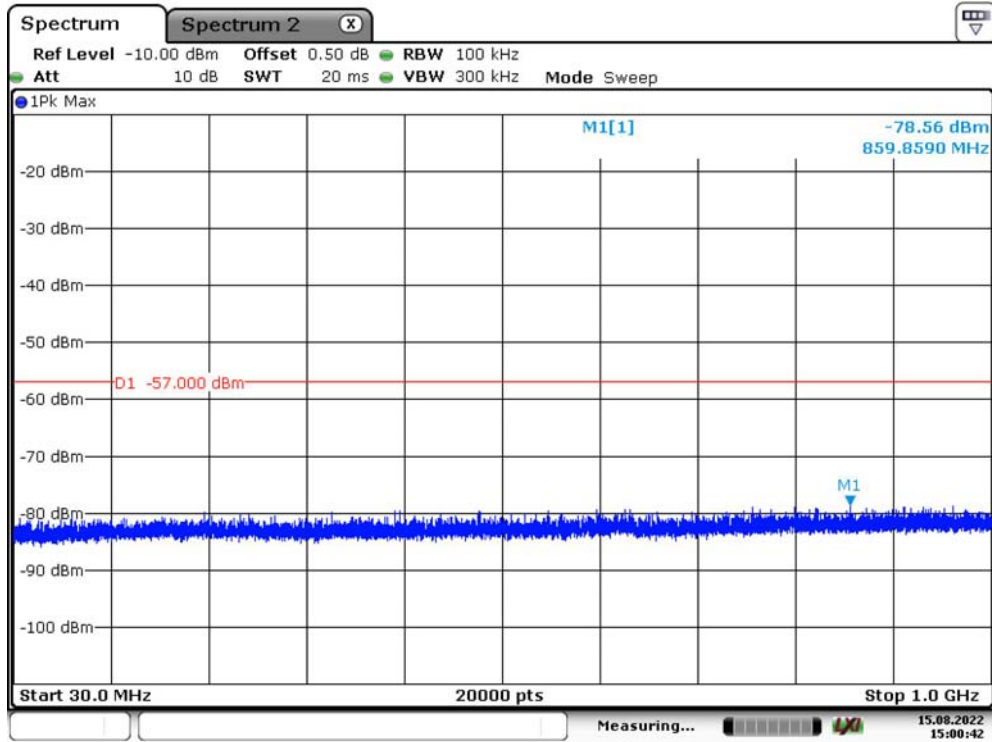

Date: 15.AUG.2022 15:00:42

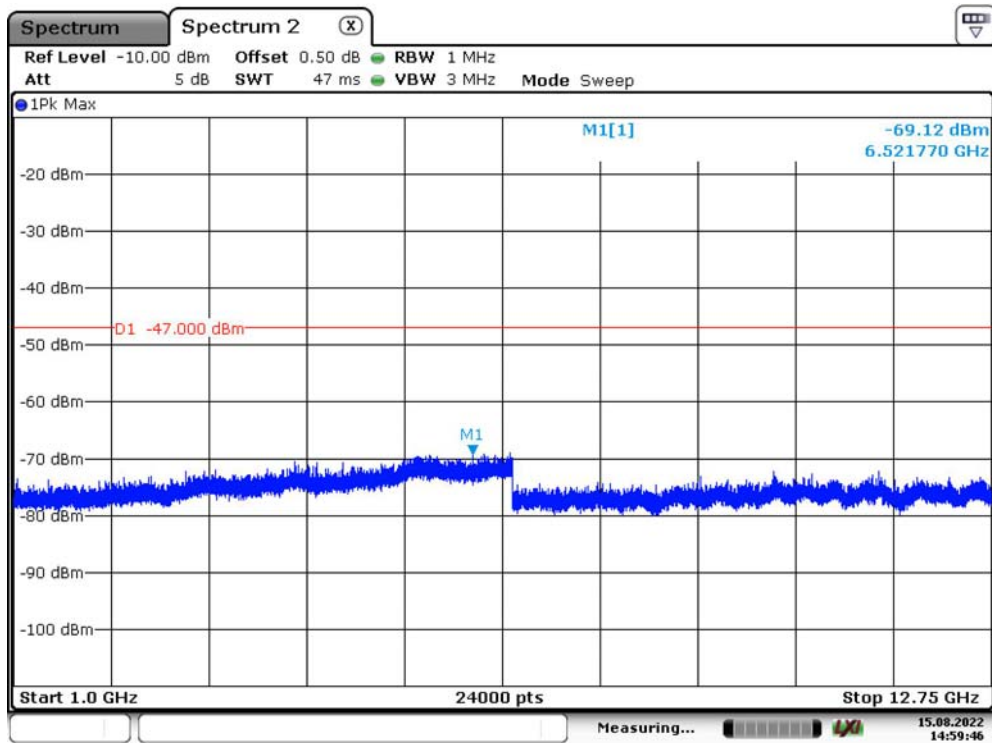

Date: 15.AUG.2022 14:59:46

802.11 n20_Low Channel

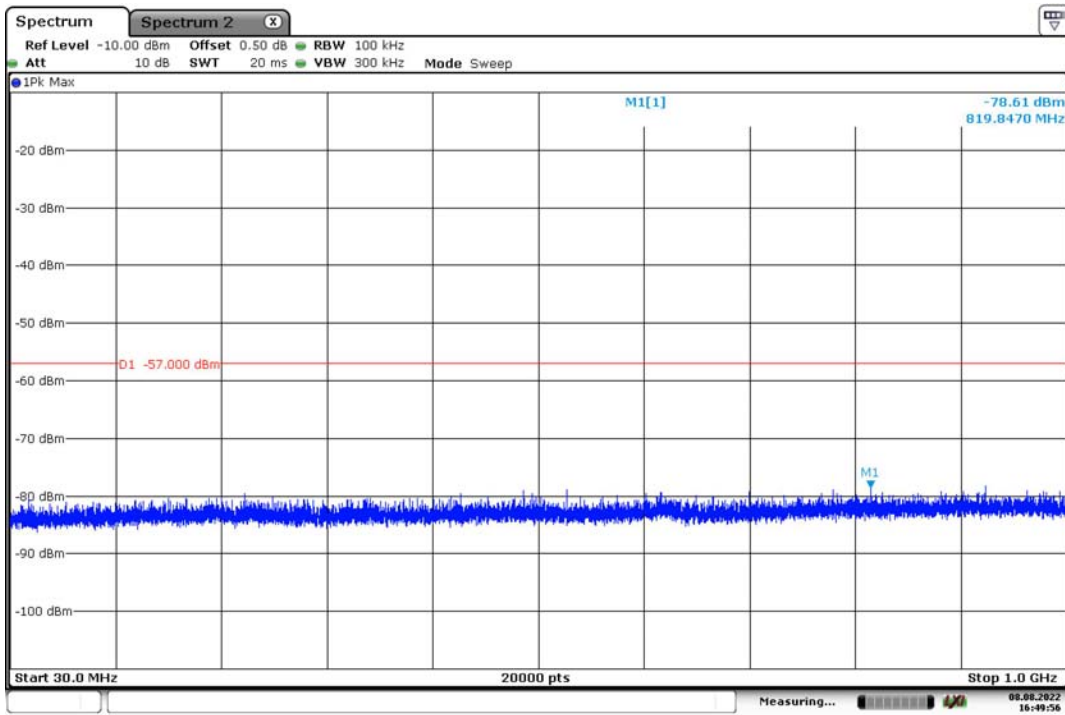

Date: 8.AUG.2022 16:49:57

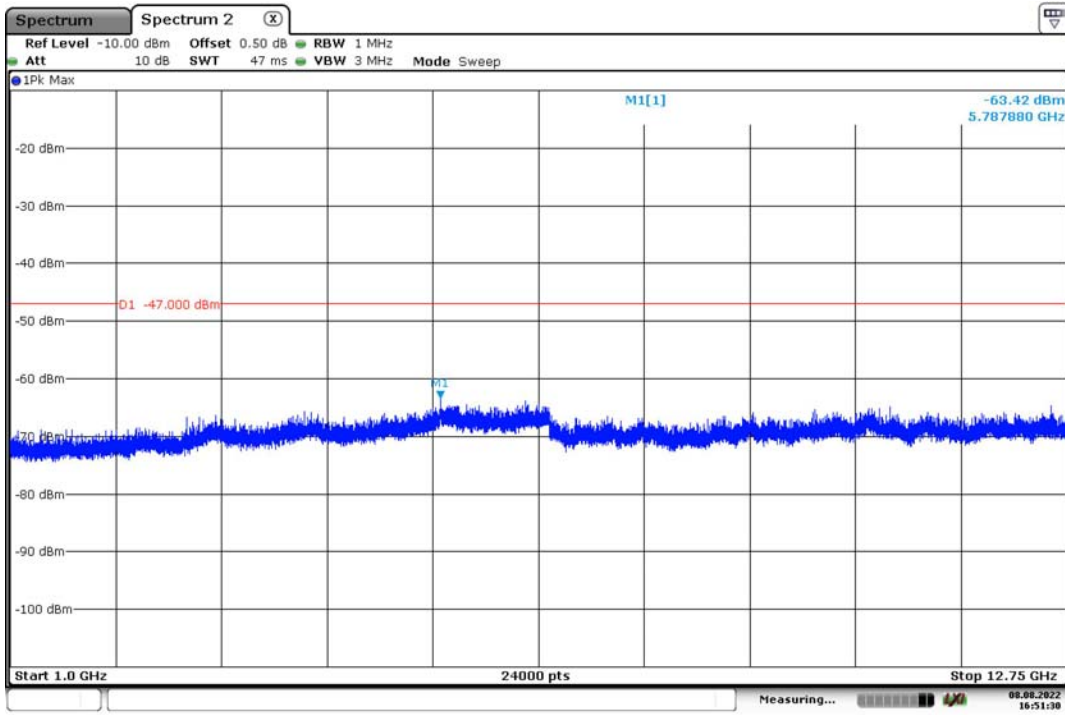

Date: 8.AUG.2022 16:51:30

802.11 n20_High Channel

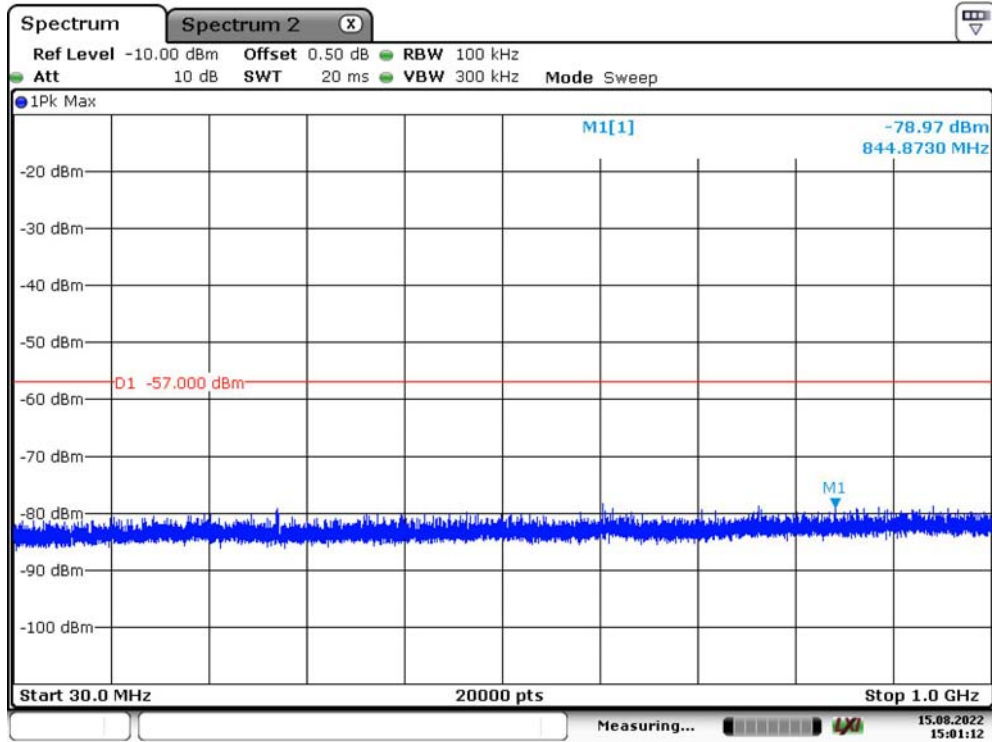

Date: 15.AUG.2022 15:01:11

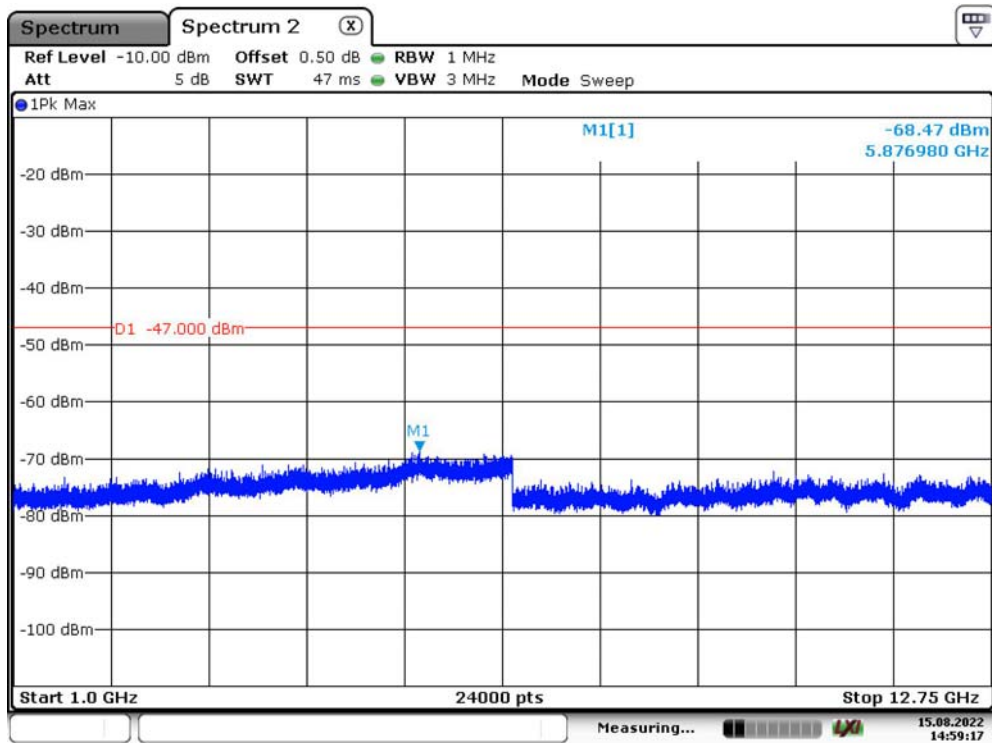

Date: 15.AUG.2022 14:59:18

802.11 n40_Low Channel

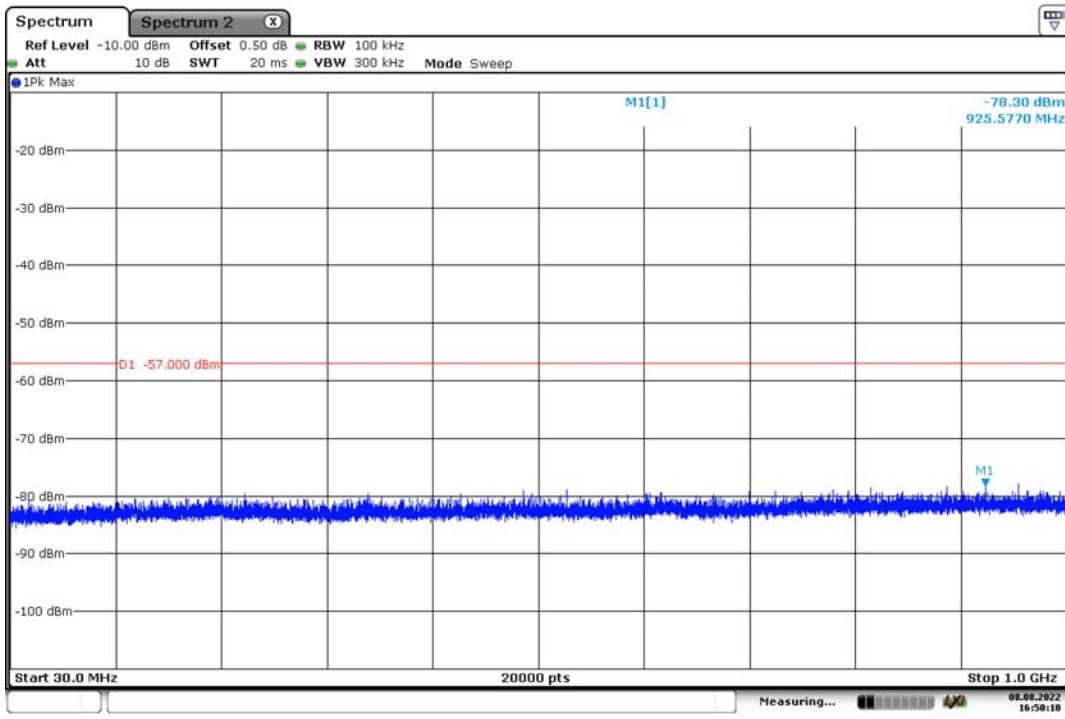

Date: 8.AUG.2022 16:50:11

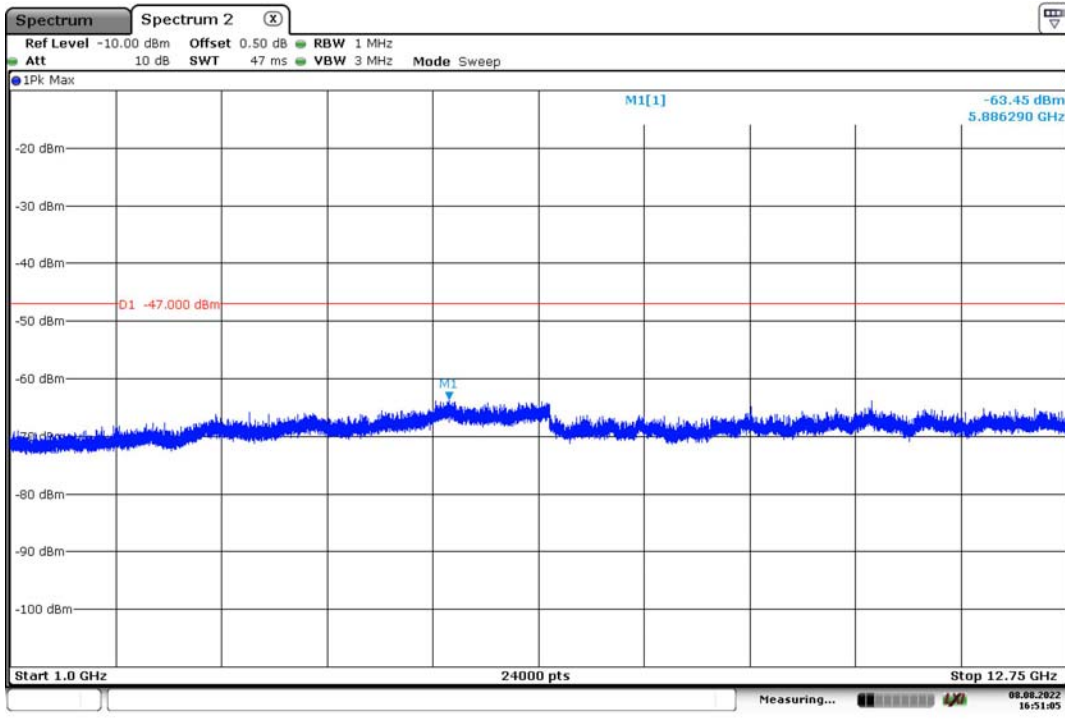

Date: 8.AUG.2022 16:51:05

802.11 n40_High Channel

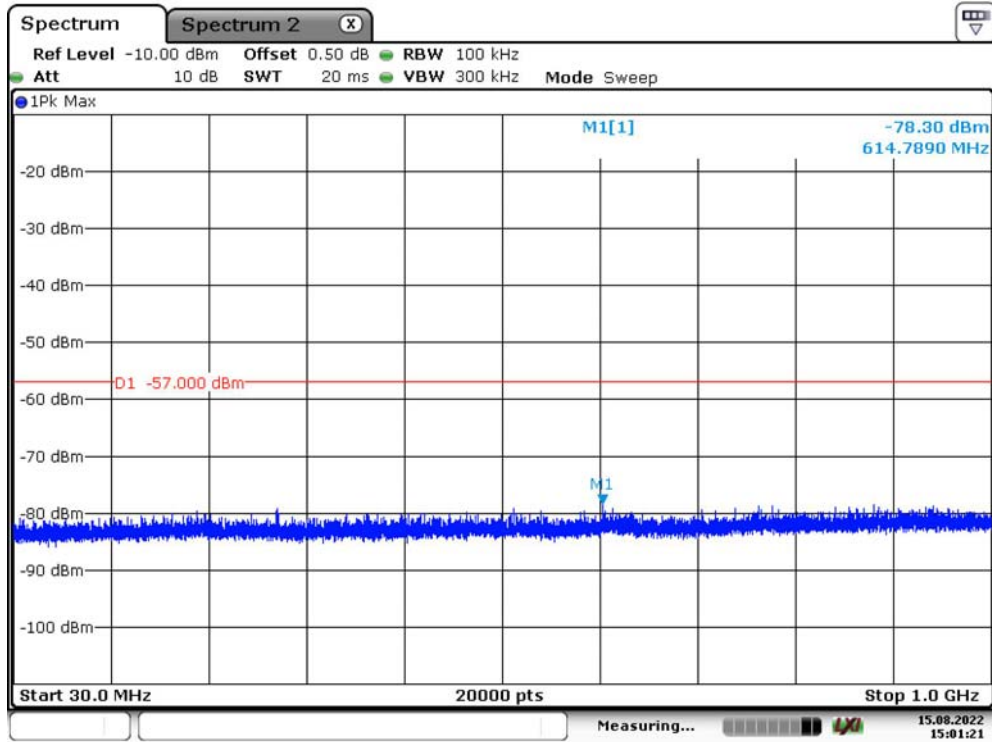

Date: 15.AUG.2022 15:01:21

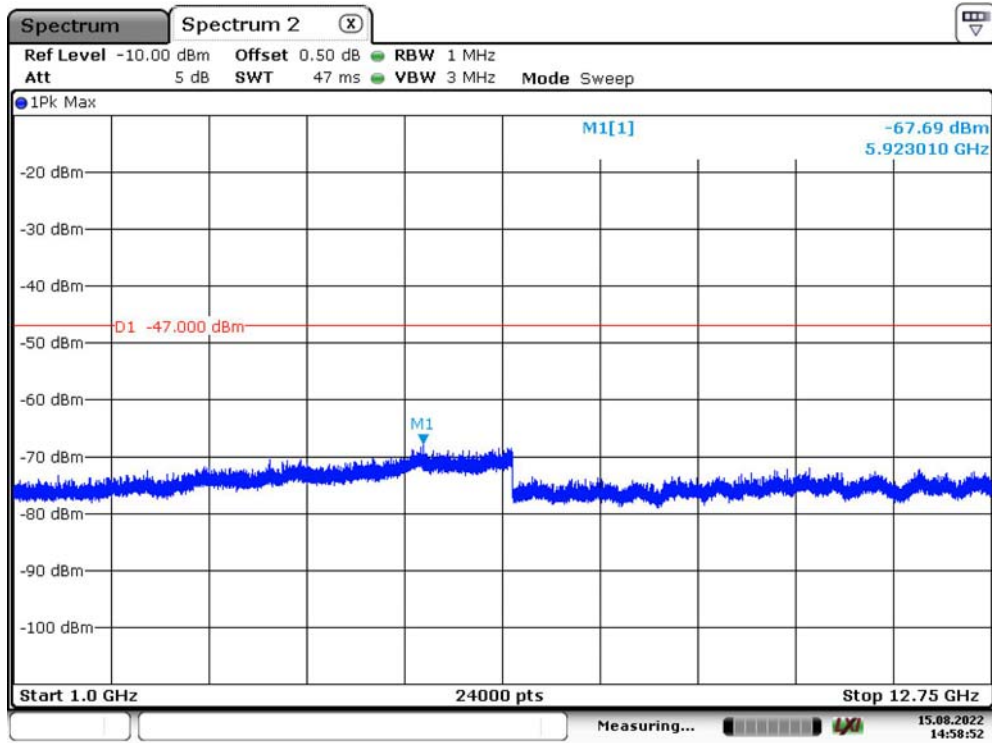

Date: 15.AUG.2022 14:58:53

10 - RECEIVER BLOCKING

Definition

Receiver blocking is a measure of the ability of the equipment to receive a wanted signal on its operating channel without exceeding a given degradation due to the presence of an unwanted input signal (blocking signal) on frequencies other than those of the operating band and spurious responses.

Limit

For equipment that supports a PER or FER test to be performed, the minimum performance criterion shall be a PER or FER less than or equal to 10 %.

For equipment that does not support a PER or a FER test to be performed, the minimum performance criterion shall be no loss of the wireless transmission function needed for the intended use of the equipment.

While maintaining the minimum performance criteria as defined in clause 4.3.2.11.3, the blocking levels at specified frequency offsets shall be equal to or greater than the limits defined for the applicable receiver category provided in table 14, table 15 or table 16.

Table 14: Receiver Blocking parameters for Receiver Category 1 equipment

Wanted signal mean power from companion device (dBm) (see notes 1 and 4)	Blocking signal frequency (MHz)	Blocking signal power (dBm) (see note 4)	Type of blocking signal
$(-133 \text{ dBm} + 10 \times \log_{10}(\text{OCBW}))$ or -68 dBm whichever is less (see note 2)	2 380 2 504	-34	CW
$(-139 \text{ dBm} + 10 \times \log_{10}(\text{OCBW}))$ or -74 dBm whichever is less (see note 3)	2 300 2 330 2 360 2 524 2 584 2 674		
<p>NOTE 1: OCBW is in Hz.</p> <p>NOTE 2: In case of radiated measurements using a companion device and the level of the wanted signal from the companion device cannot be determined, a relative test may be performed using a wanted signal up to $P_{\text{min}} + 26 \text{ dB}$ where P_{min} is the minimum level of wanted signal required to meet the minimum performance criteria as defined in clause 4.3.1.12.3 in the absence of any blocking signal.</p> <p>NOTE 3: In case of radiated measurements using a companion device and the level of the wanted signal from the companion device cannot be determined, a relative test may be performed using a wanted signal up to $P_{\text{min}} + 20 \text{ dB}$ where P_{min} is the minimum level of wanted signal required to meet the minimum performance criteria as defined in clause 4.3.1.12.3 in the absence of any blocking signal.</p> <p>NOTE 4: The level specified is the level at the UUT receiver input assuming a 0 dBi antenna assembly gain. In case of conducted measurements, this level has to be corrected for the (in-band) antenna assembly gain (G). In case of radiated measurements, this level is equivalent to a power flux density (PFD) in front of the UUT antenna with the UUT being configured/positioned as recorded in clause 5.4.3.2.2.</p>			

Table 15: Receiver Blocking parameters receiver Category 2 equipment

Wanted signal mean power from companion device (dBm) (see notes 1 and 3)	Blocking signal frequency (MHz)	Blocking signal power (dBm) (see note 3)	Type of blocking signal
(-139 dBm + 10 × log ₁₀ (OCBW) + 10 dB) or (-74 dBm + 10 dB) whichever is less (see note 2)	2 380 2 504 2 300 2 584	-34	CW
<p>NOTE 1: OCBW is in Hz.</p> <p>NOTE 2: In case of radiated measurements using a companion device and the level of the wanted signal from the companion device cannot be determined, a relative test may be performed using a wanted signal up to P_{min} + 26 dB where P_{min} is the minimum level of wanted signal required to meet the minimum performance criteria as defined in clause 4.3.1.12.3 in the absence of any blocking signal.</p> <p>NOTE 3: The level specified is the level at the UUT receiver input assuming a 0 dBi antenna assembly gain. In case of conducted measurements, this level has to be corrected for the (in-band) antenna assembly gain (G). In case of radiated measurements, this level is equivalent to a power flux density (PFD) in front of the UUT antenna with the UUT being configured/positioned as recorded in clause 5.4.3.2.2.</p>			

Table 16: Receiver Blocking parameters receiver Category 3 equipment

Wanted signal mean power from companion device (dBm) (see notes 1 and 3)	Blocking signal frequency (MHz)	Blocking signal power (dBm) (see note 3)	Type of blocking signal
(-139 dBm + 10 × log ₁₀ (OCBW) + 20 dB) or (-74 dBm + 20 dB) whichever is less (see note 2)	2 380 2 504 2 300 2 584	-34	CW
<p>NOTE 1: OCBW is in Hz.</p> <p>NOTE 2: In case of radiated measurements using a companion device and the level of the wanted signal from the companion device cannot be determined, a relative test may be performed using a wanted signal up to P_{min} + 30 dB where P_{min} is the minimum level of wanted signal required to meet the minimum performance criteria as defined in clause 4.3.1.12.3 in the absence of any blocking signal.</p> <p>NOTE 3: The level specified is the level at the UUT receiver input assuming a 0 dBi antenna assembly gain. In case of conducted measurements, this level has to be corrected for the (in-band) antenna assembly gain (G). In case of radiated measurements, this level is equivalent to a power flux density (PFD) in front of the UUT antenna with the UUT being configured/positioned as recorded in clause 5.4.3.2.2.</p>			

Test Setup Block diagram

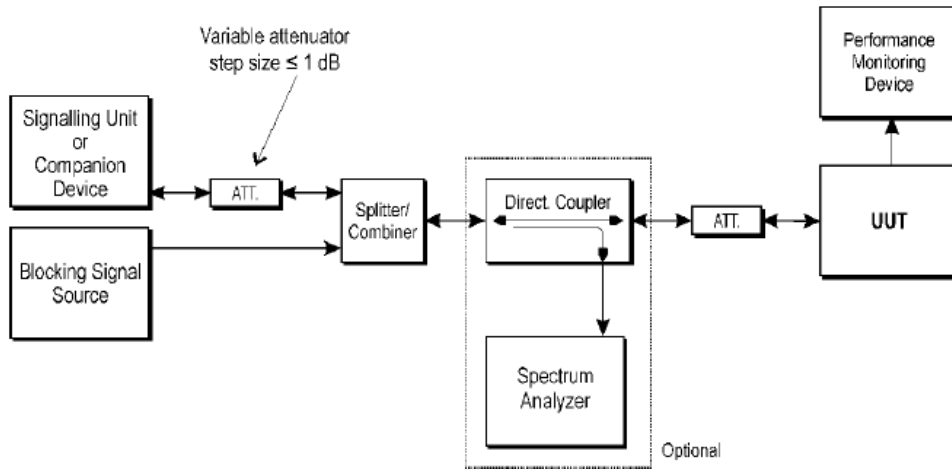

Figure 6: Test Set-up for receiver blocking

Test Procedure

The measurement procedure refer to ETSI EN 300 328 V2.2.2 (2019-07) §5.4.11

Test Data

Test Result: Compliant. Please refer to following tables.

Mode	Receiver Category	Channel	Frequency (MHz)	Blocking Signal Frequency (MHz)	PER (%)	Limit (%)
802.11b	1	Low	2412	2380	3.5	≤ 10
				2300	3.6	
				2330	3.8	
				2360	3.7	
	High	2472	2504	3.2	≤ 10	
			2524	3.7		
			2584	3.5		
			2674	3.8		

Note: PER was monitored by CMW500.

EXHIBIT A - E.2 INFORMATION AS REQUIRED BY EN 300 328 V2.2.2, CLAUSE 5.4.1

In accordance with EN 300 328, clause 5.4.1, the following information is provided by the supplier.

a) The type of modulation used by the equipment:

- FHSS
- other forms of modulation

b) In case of FHSS modulation:

In case of non-Adaptive Frequency Hopping equipment:

The number of Hopping Frequencies: _____.

In case of Adaptive Frequency Hopping Equipment:

The maximum number of Hopping Frequencies: _____;

The minimum number of Hopping Frequencies: _____;

The (average) Dwell Time: _____;

c) Adaptive / non-adaptive equipment:

- non-adaptive Equipment
- adaptive Equipment without the possibility to switch to a non-adaptive mode
- adaptive Equipment which can also operate in a non-adaptive mode

d) In case of adaptive equipment:

The Channel Occupancy Time implemented by the equipment: 5.236 ms

- The equipment has implemented an LBT based DAA mechanism

In case of equipment using modulation different from FHSS:

- The equipment is Frame Based equipment
- The equipment is Load Based equipment
- The equipment can switch dynamically between Frame Based and Load Based equipment

The CCA time implemented by the equipment: 0.060 ms

- The equipment has implemented an non-LBT based DAA mechanism
- The equipment can operate in more than one adaptive mode

e) In case of non-adaptive Equipment:

The maximum RF Output Power (e.i.r.p.): _____dBm

The maximum (corresponding) Duty Cycle: _____ %

Equipment with dynamic behaviour, that behaviour is described here. (e.g. the different combinations of duty cycle and corresponding power levels to be declared):

_____.

f) The worst case operational mode for each of the following tests:

RF Output Power: 17.49 dBm ;
 Power Spectral Density 7.47 dBm/MHz ;
 Duty cycle, Tx-Sequence, Tx-gap N/A ;
 Accumulated Transmit Time, Minimum Frequency Occupation & Hopping Sequence (only for FHSS equipment)
N/A ;
 Hopping Frequency Separation (only for FHSS equipment) N/A ;
 Medium Utilisation N/A ;
 Adaptivity Pass ;
 Receiver Blocking Pass ;
 Norminal Occupied Channel Bandwidth 20&40 MHz ;
 Transmitter unwanted emissions in the OOB domain -31.69 dBm/MHz ;
 Transmitter unwanted emissions in the spurious domain -57.03 dBm ;
 Receiver spurious emissions -60.01 dBm ;

g) The different transmit operating modes (tick all that apply):

- Operating mode 1: Single Antenna Equipment
- Equipment with only 1 antenna
- Equipment with 2 diversity antennas but only 1 antenna active at any moment in time
- Smart Antenna Systems with 2 or more antennas, but operating in a (legacy) mode where only 1 antenna is used. (e.g. IEEE 802.11™ [i.3] legacy mode in smart antenna systems)

- Operating mode 2: Smart Antenna Systems - Multiple Antennas without beam forming
- Single spatial stream / Standard throughput / (e.g. IEEE 802.11™ [i.3] legacy mode)
- High Throughput (> 1 spatial stream) using Occupied Channel Bandwidth 1
- High Throughput (> 1 spatial stream) using Occupied Channel Bandwidth 2
- Note: Add more lines if more channel bandwidths are supported.

- Operating mode 3: Smart Antenna Systems - Multiple Antennas with beam forming
- Single spatial stream / Standard throughput (e.g. IEEE 802.11™ [i.3] legacy mode)
- High Throughput (> 1 spatial stream) using Occupied Channel Bandwidth 1
- High Throughput (> 1 spatial stream) using Occupied Channel Bandwidth 2
- Note: Add more lines if more channel bandwidths are supported.

h) In case of Smart Antenna Systems:

The number of Receive chains: _____ ;
 The number of Transmit chains: _____ ;

symmetrical power distribution
 asymmetrical power distribution

In case of beam forming, the maximum beam forming gain: _____ ;

Note: Beam forming gain does not include the basic gain of a single antenna.

i) Operating Frequency Range(s) of the equipment:

Operating Frequency Range 1: 2412 MHz to 2472 MHz
 Operating Frequency Range 2: 2422 MHz to 2462 MHz
 Operating Frequency Range 3: _____ MHz to _____ MHz

Note: Add more lines if more Frequency Ranges are supported.

j) Nominal Channel Bandwidth(s):

Nominal Channel Bandwidth 1: 20 MHz
 Nominal Channel Bandwidth 2: 40 MHz

Note: Add more lines if more channel bandwidths are supported.

k) Type of Equipment (stand-alone, combined, plug-in radio device, etc.):

- Stand-alone
- Combined Equipment (Equipment where the radio part is fully integrated within another type of equipment)
- Plug-in radio device (Equipment intended for a variety of host systems)
- Other _____;

l) The normal and the extreme operating conditions that apply to the equipment:

Normal operating conditions (if applicable):

Operating temperature range: +25 ° C
 Other (please specify if applicable): _____

Extreme operating conditions:

Operating temperature range: Minimum: -40 ° C Maximum +70 ° C
 Other (please specify if applicable): _____ Minimum: _____ Maximum _____

Details provided are for the: stand-alone equipment
 combined (or host) equipment
 test jig

m) The intended combination(s) of the radio equipment power settings and one or more antenna assemblies and their corresponding e.i.r.p levels:

Antenna Type:

- Integral Antenna (information to be provided in case of conducted measurements)

Antenna Gain: 3.89 dBi

If applicable, additional beamforming gain (excluding basic antenna gain): _____ dB

- Temporary RF connector provided
- No temporary RF connector provided

- Dedicated Antennas (equipment with antenna connector)
 - Single power level with corresponding antenna(s)
 - Multiple power settings and corresponding antenna(s)

Number of different Power Levels: _____;
 Power Level 1: _____ dBm
 Power Level 2: _____ dBm
 Power Level 3: _____ dBm

Note 1: Add more lines in case the equipment has more power levels.
 Note 2: These power levels are conducted power levels (at antenna connector).

For each of the Power Levels, provide the intended antenna assemblies, their corresponding gains (G) and the resulting e.i.r.p. levels also taking into account the beamforming gain (Y) if applicable

Power Level 1: ___dBm

Number of antenna assemblies provided for this power level:

Assembly #	Gain (dBi)	e.i.r.p. (dBm)	Part number or model name
1			
2			
3			
4			

Note 3: Add more rows in case more antenna assemblies are supported for this power level.

Power Level 2: ___dBm

Number of antenna assemblies provided for this power level:

Assembly #	Gain (dBi)	e.i.r.p. (dBm)	Part number or model name
1			
2			
3			
4			

Note4: Add more rows in case more antenna assemblies are supported for this power level.

Power Level 2: ___dBm

Number of antenna assemblies provided for this power level:

Assembly #	Gain (dBi)	e.i.r.p. (dBm)	Part number or model name
1			
2			
3			
4			

Note5: Add more rows in case more antenna assemblies are supported for this power level.

n) The nominal voltages of the stand-alone radio equipment or the nominal voltages of the combined (host) equipment or test jig in case of plug-in devices:

Details provided are for the: stand-alone equipment
 combined (or host) equipment
 test jig

Supply Voltage AC mains State AC voltage 100-240 V
 DC State DC voltage 9-48 V

In case of DC, indicate the type of power source
 Internal Power Supply
 External Power Supply or AC/DC adapter
 Battery
 Other: _____.

o) Describe the test modes available which can facilitate testing:

The measurements shall be performed during continuously transmitting.

p) The equipment type (e.g. Bluetooth®, IEEE 802.11™, IEEE 802.15.4™, proprietary, etc.):

IEEE 802.11™.

q) If applicable, the statistical analysis referred to in clause 5.4.1 q)

(to be provided as separate attachment)

r) If applicable, the statistical analysis referred to in clause 5.4.1 r)

(to be provided as separate attachment)

s) Geo-location capability supported by the equipment:

- Yes
- The geographical location determined by the equipment as defined in clause 4.3.1.13.2 or clause 4.3.2.12.2 is not accessible to the user.
- No

EXHIBIT B - EUT PHOTOGRAPHS

For photos in this section, please refer to report No.: XMDN220429-17582E-02 EXHIBIT A.

EXHIBIT C – TEST SETUP PHOTOGRAPHS

Radiated Emission Below 1GHz View



Radiated Emission Above 1GHz View

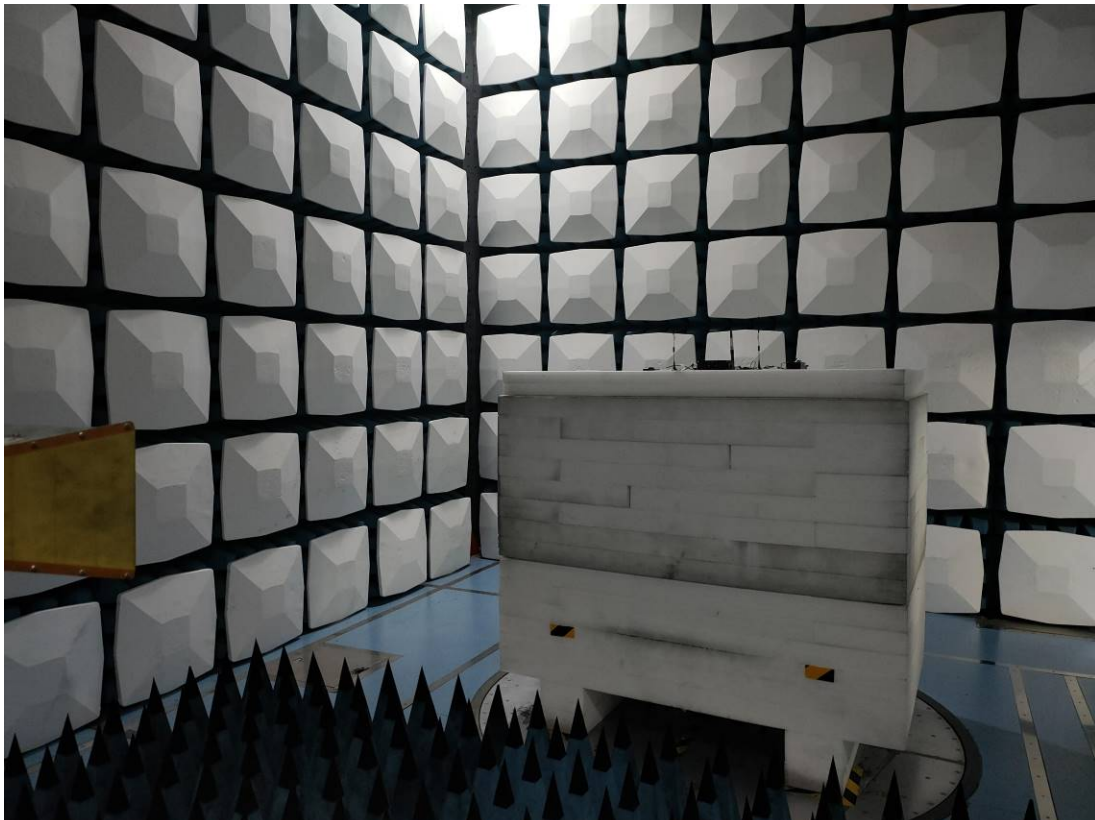

*****END OF REPORT*****