

### 1 Introduction

The Multifunction Energy Meter, SDM120-MOD-MID, is a new generation DIN rail mounted meter, used not only in the electricity transmission and power distribution system but also in power consumption measurement and analysis in high voltage intelligent power grid.

This document provides operating, maintenance and installation instructions for the SDM120-MOD-MID. The unit measures and displays the characteristics of single phase two wire supplies including voltage, frequency, current, power, active and reactive energy, imported or exported. Energy is measured in kWh and kVAh.

The SDM120-MOD-MID features two built-in pulsed outputs and RS485 Modbus RTU comms. Configuration is modified through Modbus interrogation.

#### 1.1 Unit Characteristics

The SDM120-MOD-MID can measure and display:

- Voltage
- Current
- Frequency
- Active & Reactive Power, Power Factor
- Imported, Exported & Total Active Energy
- Imported, Exported & Total Reactive Energy

A pulsed output indicates real-time energy measurement. An RS485 output allows remote monitoring & unit configuration from another display or a computer.



#### 1.2 RS485 Serial – Modbus RTU

This uses an RS485 serial port with Modbus RTU protocol to provide a means of remotely monitoring and controlling the SDM120-MOD-MID.

#### 1.3 Pulse output

This unit has 2 built-in pulsed outputs that record measured active and reactive energy. The constant for reactive energy is 1000imp/kVAh. The pulse width for active energy can be set through Modbus.

### 2 Start Up Screens

	The first screen lights all display segments and can be used as a display check.
	The second screen indicates the firmware installed in the unit and its build number.









\*After a short delay, the screen will display the total active energy measurement.

### 3 Buttons

	This is the button used to rotate through the different parameter options. Holding this button will enable the "Set" mode for writing to the meter via Modbus
--	---

### 3.1 Measurements

Each successive press of the  button selects a new parameter:

	Total active energy ( $\Sigma$ kWh).
	Imported active energy (kWh).
	Exported active energy (kWh).
	Voltage Input (V).
	Current Input (A).
	Instantaneous Active Power (W).
	Frequency (Hz).
	Power Factor (PF).

### 4 Set Up

To enter set-up mode, hold the  button for 5 seconds, until the 'set' screen appears.

	To enable 'write' function through modbus, the meter must be on 'set' mode.
---	---

To exit the set-up menu, hold the  button for 5 seconds, until the 'set' screen disappears.

### 5 Specifications

The SDM120-MOD-MID can monitor and display the following parameters of a single phase supply:

#### 5.1.1 Voltage and Current

- Phase to Neutral Voltage - 176 to 276V AC
- Phase Current - I<sub>min</sub>-I<sub>b</sub>(I<sub>max</sub>) 0.25-5(45)A AC

#### 5.1.2 Power factor and Frequency

- Frequency in Hz
- Instantaneous Power 0 to 999mW
- Reactive Power 0 to 999mVAR
- Volt-amps 0 to 999 mVA

#### 5.1.3 Energy Measurements

• Imported active energy	0 to 99999.9 kWh
• Exported active energy	0 to 99999.9 kWh
• Imported reactive energy	0 to 99999.9 kVAh
• Exported reactive energy	0 to 99999.9 kVAh
• Total active energy	0 to 99999.9 kWh
• Total reactive energy	0 to 99999.9 kVAh

#### 5.2 Accuracy

• Voltage	0.5% of range maximum
• Current	0.5% of nominal
• Frequency	0.2% of mid-frequency
• Power factor	1% of unity (0.01)
• Active power (W)	±1% of range maximum
• Reactive power (VAR)	±2% of range maximum
• Apparent power (VA)	±1% of range maximum
• Active energy (Wh)	Class 1 IEC 62053-21
• Reactive energy (VARh)	±2% of range maximum

### 6.1 Dimensions

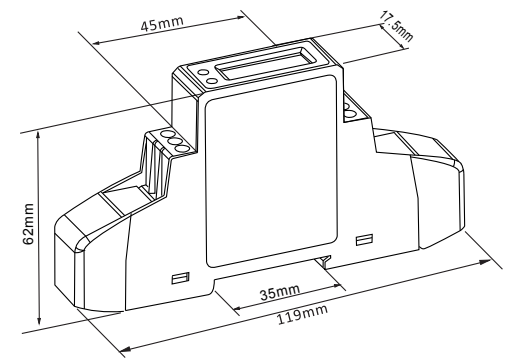

### 6.2 Wiring Diagram

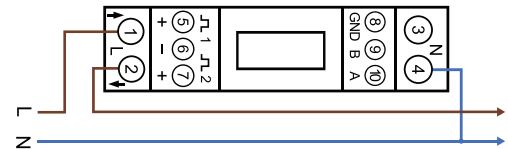

#### 7.1 Interfaces for External Monitoring

Three interfaces are provided:

- RS485 communication channel that can be programmed for Modbus RTU protocol
- Relay output indicating real-time measured energy. (configurable)
- Pulse output 1000imp/kWh (not configurable)

#### 7.2 RS485 Output for Modbus RTU

For Modbus RTU, the following RS485 communication parameters can be configured from the set-up menu:

Baud rate 1200, 2400, 4800, 9600

Parity none / odd / even

RS485 network address 3-digit number, 1 to 247

Modbus™ Word order Hi/Lo byte order is set automatically to normal or reverse. It cannot be configured from the set-up menu.

#### 7.3 Reference Conditions of Influence Quantities

Influence Quantities are variables that affect measurement errors to a minor degree. Accuracy is verified under nominal value (within the specified tolerance) of these conditions.

• Ambient temperature	23°C ±1°C
• Input waveform	50 or 60Hz ±2%
• Input waveform	Sinusoidal (distortion factor < 0.005)
• Magnetic field of external origin	Terrestrial flux

#### 7.4 Environment

• Operating temperature	-25°C to +55°C*
• Storage temperature	-40°C to +70°C*
• Relative humidity	0 to 90%, non-condensing
• Altitude	Up to 2000m
• Warm up time	1 minute
• Vibration	10Hz to 50Hz, IEC 60068-2-6, 2g
• Shock	30g in 3 planes

\*Maximum operating and storage temperatures are in the context of typical daily and seasonal variation.

#### 7.5 Declaration of Conformity

We, Smart Process & Control LTD, declare under our sole responsibility as the manufacturer that the single phase multifunction electrical energy meter "SMARTTRAIL X45M", corresponds to the production model described in the EC-type examination certificate and to the requirements of the Directive 2004/22/EC EC type examination certificate number 0120/SGS0221. Identification number of the NB 0120.